





OUTDOOR LIGHTING FOR TOUGH CLIMATE CONDITIONS

NORLYS is a Scandinavian company with a 50 years history in the professional lighting business. We offer one of the largest product ranges in decorative outdoor lighting and we deliver highest quality all over the world.

No secret: Our quality comes from the choice of excellent raw-material in combination with a perfectly controlled production process.

All our products are made in Europe in our own ISO 9001, IATF 16949 and ISO 14001 certified factory. Our manufacturing facility is over 15000m² and we use the latest technology across all aspects of production. Steady investment keeps us on the top of the industrial process. A good example is our foundry, one of the most modern installations in Europe.

When we cannot do it alone, we carefully choose our partners. This is especially important in the field of LED technology. We use the best LED quality from the very best suppliers. No compromise allowed!

Good design, large choice, excellent quality: indeed that's what our customers appreciate! In this world of quick exchange, it is equally important to work on high delivery-speed. This is why we have several very large warehouses with thousands of finished products ready to be shipped. If something is not already in stock, we aim to produce within days.

INDEX

WALL



ARENDAL p.43



ASKER p.9



ASKER BIG p.10



BASEL p.25



BERGEN p.41



BERLIN p.34



BERN p.25



BODEN p.27



BOLOGNA p.52



BORNHOLM p.35



BREMEN p.34



CHELSEA p.55



CHELSEA p.55



COMO p.52



FIRENZE p.53



GENEVA p.21



GENOVA p.56



GENOVA MINI p.56



GLASGOW p.57



HALDEN p.31



HITRA p.21



KARLSTAD p.40



KOSTER p.45



LARVIK p.38



LILLEHAMMER p.17



LOFOTEN p.47



LOFOTEN p.47



LONDON p.57



LONDON p.49



LUND p.39



NEW

LYSFJORD p.19



MANDAL p.15



MODENA p.51



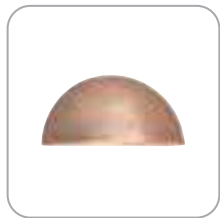
NAMSOS p.59



NORDLAND p.23



OSLO p.38



PARIS p.33



PARIS BIG p.33



RIMINI p.53



RONDANE p.35



SANDVIK p.13



SKI p.29



STOCKHOLM p.36



STOCKHOLM p.37



VANSBRO p.41



VASA p.31



VOSS p.18

BOLLARD



ALTA p.93



ALTA p.95



ARENDAL p.101



ARVIKA p.89



ASKER p.85



BOLOGNA p.128



BORG p.91



CHELSEA p.127



COMO p.124



EGERSUND p.78



EGERSUND MINI p.79



EGERSUND MINI p.94



FIRENZE p.125



HALMSTAD p.97



HALMSTAD p.95



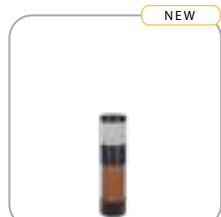
HELLVIK p.90



KISA p.81



LILLESAND p.93



LILLESAND p.94



LOFOTEN p.119



LOFOTEN p.119



LONDON p.120



MODENA p.122



MOLDE p.87



NAMSOS p.88



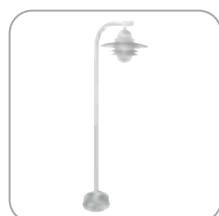
NARVIK p.77



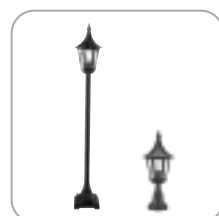
OPPLAND p.81



OPPLAND p.94



OSLO p.117



RIMINI p.126



STAVANGER p.75



STOCKHOLM p.114



STOCKHOLM p.98



STOCKHOLM p.95

INDEX

POLE



ASKER p.110



BOLOGNA p.128



BORG p.105



CHELSEA p.127



COMO p.124



EGERSUND PARK p.109



FIRENZE p.125



HAMMERFEST p.107



NEW

KARLSTAD p.117



NEW

KISA p.111



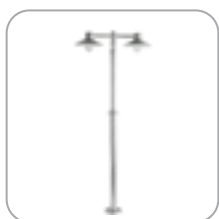
KOSTER p.113



LOFOTEN p.119



LONDON p.121



LUND p.116



MODENA p.123



NICE p.103



OSLO p.117



RIMINI / MILANO p.126



STOCKHOLM p.115



VISBY p.102

RECESSED / SPOT



GRIMSTAD p.60



NEW

MOSS p.65



NEW

MOSS p.65



NEW

MOSS p.65



NEW

MOSS p.66



NEW

MOSS p.66



NEW

MOSS p.66



NEW

MOSS p.67



NEW

MOSS p.67



NAMSOS p.61



NAMSOS p.61



NAMSOS MINI p.59



RENA p.63



RENA p.63



RENA COVER p.62



RENA COVER p.62



SANDE p.64



SANDE p.64

INDEX

CEILING



BERGEN p.70



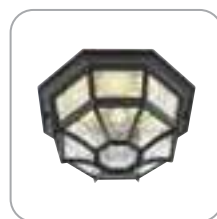
BORNHOLM p.35



CHELSEA p.73



KARLSTAD p.71



LATINA p.70



LOFOTEN p.72



LOFOTEN p.72



LOFOTEN p.72



LONDON p.73



NIDAROS p.68



NORDLAND p.23



OSLO p.71



RONDANE p.35



SANDVIK p.69

NEW

ACCESSORIES



POLES
p.129



CONCRETING ANCHORS
p.130 / 131



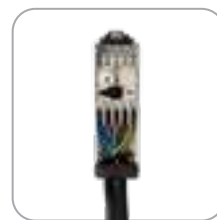
ANCHORING SUPPORTS
p.130 / 131



CORNER BRACKETS
p.130 / 131



ADAPTERS
p.130 / 131

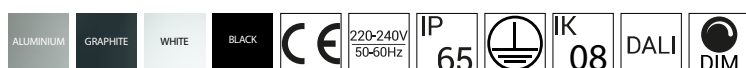


ELECTRICAL
p.130 / 131



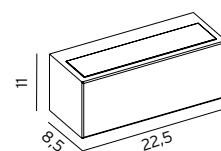


ASKER



ASKER Aluminium powder coated wall light. Supplied with transparent polycarbonate diffuser with structure.

Art	Watt	Type of light source	Luminous flux	Colour temperature	L70B50	Version	Light control
1510	8,8W	LED	312 lm	3000K	50 000h	Up & Down	Dim. Triac
5102*	8W	LED	387 lm	4000K	50 000h	Up & Down	Dim. Triac
1513	-	E27	-	-	-	Up & Down	-
1720	8,4W	LED	798 lm	3000K	70 000h	Up & Down	Dim. Triac
5150*	8,3W	LED	764 lm	4000K	70 000h	Up & Down	Dim. Triac
1721	9,9W	LED	787 lm	3000K	70 000h	Up & Down	DALI
1511	8W	LED	156 lm	3000K	50 000h	Down	Dim. Triac
5103*	8W	LED	193 lm	4000K	50 000h	Down	Dim. Triac
1514	-	E27	-	-	-	Down	-
1726	5,4W	LED	429 lm	3000K	70 000h	Down	Dim. Triac
5151*	5,4W	LED	444 lm	4000K	70 000h	Down	Dim. Triac
1727	5,5W	LED	429 lm	3000K	70 000h	Down	DALI
5157*	5,5W	LED	448 lm	4000K	70 000h	Down	Dim. Triac



Art. 1510
Art. 5102*
Art. 1513
Art. 1720
Art. 5150*
Art. 1721



Art. 1511
Art. 5103*
Art. 1514
Art. 1726
Art. 5151*
Art. 1727
Art. 5157*

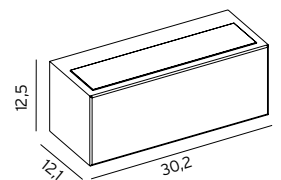
*2700/4000K available by request, contact your supplier.



ASKER BIG Aluminium powder coated wall light. Supplied with transparent polycarbonate diffuser with structure.

Art.	Watt	Type of light source	Luminous flux	Colour temperature	L70B50	Version	Light control
1300	8,3W	LED	547 lm	3000K	70 000h	Up & Down	Dim. Triac
5018*	8,3W	LED	550 lm	4000K	70 000h	Up & Down	Dim. Triac
1303	-	E27	-	-	-	Up & Down	-
1306	13,7W	LED	1280 lm	3000K	70 000h	Up & Down	Dim. Triac
5105*	13,7W	LED	1321 lm	4000K	70 000h	Up & Down	Dim. Triac
1302	5,2W	LED	306 lm	3000K	70 000h	Down	Dim. Triac
5104*	5,2W	LED	362 lm	4000K	70 000h	Down	Dim. Triac
1305	-	E27	-	-	-	Down	-
1308	8,4W	LED	732 lm	3000K	70 000h	Down	Dim. Triac

2700/4000K available by request, contact your supplier.



Art. 1300
Art. 1303
Art. 1306
Art. 5018*
Art. 5105*



Art. 1302
Art. 1305
Art. 1308
Art. 5104*

ASKER BIG

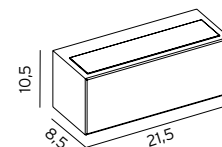


ASKER (GALVANIZED)



ASKER (GALVANIZED) Front in galvanized steel and wallplate in aluminium. Transparent polycarbonate diffuser with structure.

Art.	Watt	Type of light source	Luminous flux	Colour temperature	L70B50	Version	Light control
1700	8W	LED	398 lm	3000K	50 000h	Up & Down	Dim. Triac
1702	-	E27	-	-	-	Up & Down	-
1705	8W	LED	165 lm	3000K	50 000h	Down	Dim. Triac



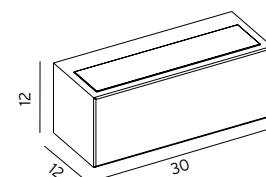
Art. 1700
Art. 1702



Art. 1705
Art. 1707

ASKER (GALVANIZED - Big) Front in galvanized steel and wallplate in aluminium. Transparent polycarbonate diffuser with structure.

Art.	Watt	Type of light source	Luminous flux	Colour temperature	L70B50	Version	Light control
1710	7,1W	LED	649 lm	3000K	70 000h	Up & Down	Dim. Triac
1712	-	E27	-	-	-	Up & Down	-
1715	5,3W	LED	347 lm	3000K	70 000h	Down	Dim. Triac



Art. 1710
Art. 1712



Art. 1715
Art. 1717

2700/4000K available by request, contact your supplier.



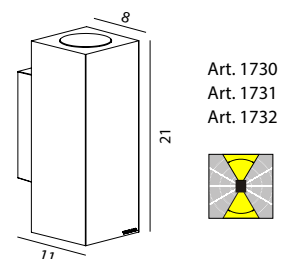


SANDVIK



SANDVIK Aluminium powder coated up & down wall light. Tempered clear glass.

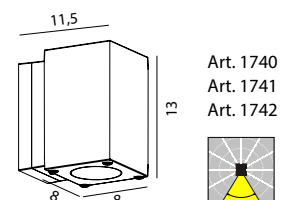
Art	Watt	Type of light source	Luminous flux	Colour temperature	L70B50	Version	Light control
1730	2x max 4W	2x LED GU10	-	-	-	Up & Down	-
1731	2x3,9W	2x LED GU10	420 lm	2700K	40 000h	Up & Down	Dim. Triac
1732*	2x8W	LED	1126 lm	3000K	50 000h	Up & Down	Dim. Triac



Art. 1730
Art. 1731
Art. 1732

SANDVIK Aluminium powder coated down wall light. Tempered clear glass.

Art	Watt	Type of light source	Luminous flux	Colour temperature	L70B50	Version	Light control
1740	max 4W	LED GU10	-	-	-	Down	-
1741	3,9W	LED GU10	210 lm	2700K	40 000h	Down	Dim. Triac
1742*	8W	LED	563 lm	3000K	50 000h	Down	Dim. Triac



Art. 1740
Art. 1741
Art. 1742

Accessories Sandvik

148	Cornerbracket	p. 131
-----	---------------	--------

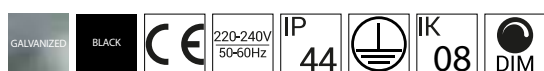
Art. 1731: 2x3,9W LED GU10 included, 2x265lm, 2700K, 40000h, 25D, dimmable. art. 1741: 3,9W LED GU10 included, 265lm, 2700K, 40000h, 25D, dimmable. art. 1732 Light distribution 36D.

*2700/4000K available by request, contact your supplier.





MANDAL



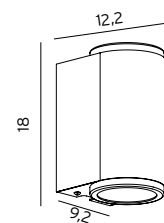
MANDAL Galvanized steel or powder coated galvanized steel. Tempered clear glass.

Art	Watt	Type of light source	Luminous flux	Colour temperature	L70B50	Version	Light control
1370	2x3,9W	2x GU10	500 lm	2700K	40 000h	Up & Down	Dim. Triac
1371	2x max 4W	2x GU10	-	-	-	Up & Down	-
1373	3,9W	LED GU10	250 lm	2700K	40 000h	Down	Dim. Triac
1374	max 4W	LED GU10	-	-	-	Down	-

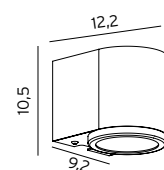
Accessories Mandal

130	Corner bracket	Art.1373, 1374	p. 131
149	Corner bracket	Art.1370, 1371	p. 131

Art. 1370: 2x3,9W LED GU10 included, 2x265lm, 2700K, 40000h, 25D, dimmable. art. 1373: 3,9W LED GU10 included, 265lm, 2700K, 40000h, 25D, dimmable.



Art. 1370, 1371



Art. 1373, 1374







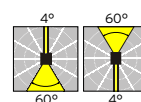
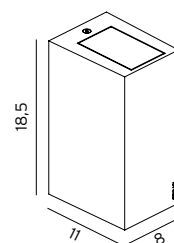
LILLEHAMMER



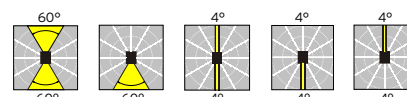
LILLEHAMMER Aluminium powder coated wall light. Clear glass. Art. 1580, 5027 can be turned both ways.

Art	Watt	Type of light source	Luminous flux	Colour temperature	L70B50	Light control
1580	7,1W	LED	129 lm	3000K	50 000h	Dim. Triac
5027*	7,6W	LED	127 lm	4000K	50 000h	Dim. Triac
1581	7,1W	LED	205 lm	3000K	50 000h	Dim. Triac
5028*	7,7W	LED	210 lm	4000K	50 000h	Dim. Triac
1582	4,2W	LED	103 lm	3000K	50 000h	Dim. Triac
5029*	4,2W	LED	111 lm	4000K	50 000h	Dim. Triac
1583	7,1W	LED	34 lm	3000K	50 000h	Dim. Triac
5030*	7,1W	LED	32 lm	4000K	50 000h	Dim. Triac
1584	4,2W	LED	17 lm	3000K	50 000h	Dim. Triac
5031*	4,2W	LED	16 lm	4000K	50 000h	Dim. Triac
1585	4,2W	LED	17 lm	3000K	50 000h	Dim. Triac
1586*	4,2 W	LED	16 lm	4000K	50 000h	Dim. Triac

*2700/4000K available by request, contact your supplier.



Art. 1580, 5027*



Art. 1581 Art. 1582 Art. 1583 Art. 1584 Art. 1585
Art. 5028* Art. 5029* Art. 5030* Art. 5031* Art. 1586

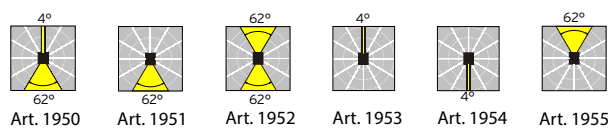
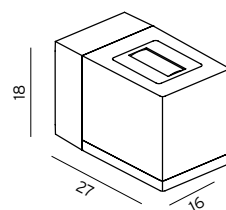


VOSS



VOSS Aluminium powder coated wall light. Clear glass.

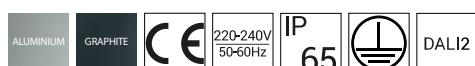
Art	Watt	Type of light source	Luminous flux	Colour temperature	L70/B50
1950	16,9W	LED	614 lm	3000K	50 000h
1951	11,8W	LED	558 lm	3000K	50 000h
1952	22,2W	LED	1116 lm	3000K	50 000h
1953	6,4W	LED	55,7 lm	3000K	50 000h
1954	6,4W	LED	55,7 lm	3000K	50 000h
1955	11,8W	LED	558 lm	3000K	50 000h



2700/4000K available by request, contact your supplier.

LYSFJORD

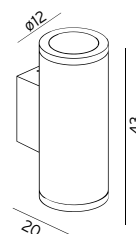
NEW



LYSFJORD Aluminium powder coated wall light. Clear glass.

Art	Watt	Type of light source	Luminous flux	Colour temperature	L70/B50	Light control
6401	26,5W	LED	946 lm	3000K	>70 000h	DALI2
6402	26,5W	LED	946 lm	3000K	>70 000h	DALI2
6403	26,5W	LED	1813 lm	3000K	>70 000h	DALI2
6404	26,5W	LED	78 lm	3000K	>70 000h	DALI2

2700/4000K available by request, contact your supplier.



Art. 6401



Art. 6402



Art. 6403



Art. 6404



HITRA



GENEVA



HITRA Aluminium powder coated down wall light, supplied with tempered clear glass.

Art	Watt	Type of light source	Luminous flux	Colour temperature	L70B50	Version	Light control
1330	9,5W	LED	920 lm	3000K	50 000h	Down	On/off
5114*	9,5W	LED	979 lm	4000K	50 000h	Down	On/off
1331	17,5W	LED	1599 lm	3000K	50 000h	Down	On/off

Accessories Art. 1330, 1330

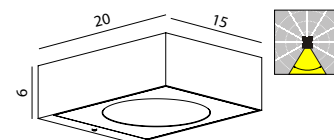
151	Corner bracket	p.131
-----	----------------	-------

*2700/4000K available by request, contact your supplier.

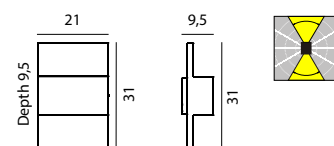
GENEVA Aluminium powder coated up and down wall light, supplied with satin polycarbonate diffuser.

Art	Watt	Type of light source	Luminous flux	Colour temperature	L70B50	Version	Light control
874	-	E27	-	-	-	Up & Down	-
879	8W	LED	350 lm	3000K	50 000h	Up & Down	Dim. Triac
5108*	8W	LED	352 lm	4000K	50 000h	Up & Down	Dim. Triac

*2700/4000K or DALI available by request, contact your supplier.

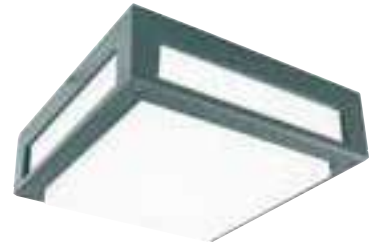


Art. 1330
Art. 1331
Art. 5114*

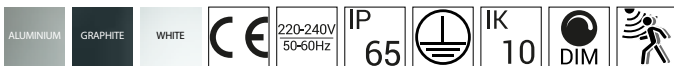


Art. 874
Art. 879
Art. 5108*





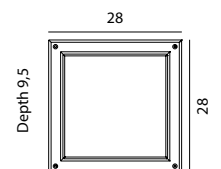
NORDLAND



NORDLAND Powder coated aluminium wall light supplied with opal PC diffuser. Suitable for wall and ceiling mounting.

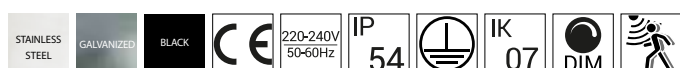
Art	Watt	Type of light source	Luminous flux	Colour temperature	L70B50	Light control	Sensor HF
718	10W	LED	598 lm	3000K	50 000h	Dim. Triac	-
5016*	10W	LED	672 lm	4000K	50 000h	Dim. Triac	-
5041	17,5W	LED	1249 lm	3000K	50 000h	On/off	-
5017*	17,5W	LED	1358 lm	4000K	50 000h	On/off	-
5043	17,5W	LED	1318 lm	3000K	50 000h	On/off	Yes
7120	2x max9W	2x LED E27	-	-	-	-	-

* 2700/4000K available by request, contact your supplier.

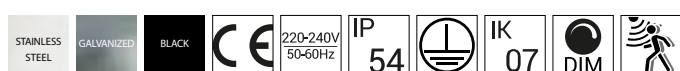




BASEL



BERN



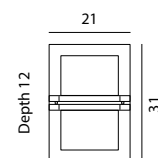
BASEL Wallplate in aluminium. Front in galvanized steel, stainless steel or galvanized and powder coated. Heavy clear or frosted glass.

Art	Watt	Type of light source	Luminous flux	Colour temperature	L70B50	Diffuser	Light control	Sensor HF
660	-	E27	-	-	-	Clear	-	-
661	-	E27	-	-	-	Frosted	-	-
661MD	Max LED 9W	E27	-	-	-	Frosted	-	Yes
668	5,2W	LED	483 lm	3000K	>70 000h	Frosted	Dim. Triac	-
671	10W	LED	782 lm	3000K	50 000h	Frosted	-	Yes
681	4,5W	LED	231 lm	3000K	50 000h	Frosted	Dim. Triac	-

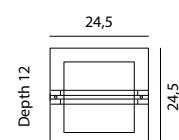
BERN Wallplate in aluminium. Front in galvanized steel, stainless steel or galvanized and powder coated. Heavy clear or frosted glass.

Art	Watt	Type of light source	Luminous flux	Colour temperature	L70B50	Diffuser	Light control	Sensor HF
650	-	E27	-	-	-	Clear	-	-
651	-	E27	-	-	-	Frosted	-	-
655	5,2W	LED	487 lm	3000K	>70 000h	Frosted	Dim. Triac	-
657	4,5W	LED	231 lm	3000K	50 000h	Frosted	Dim. Triac	-
675	11,2W	LED	800 lm	3000K	50 000h	Frosted	-	Yes

2700/4000K available by request, contact your supplier.



Art. 660
Art. 661
Art. 661MD
Art. 681

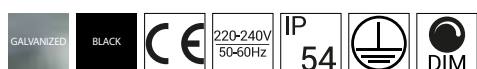


Art. 650
Art. 651
Art. 657





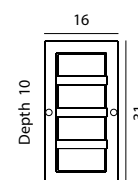
BODEN



BODEN Wallplate in aluminium. Front in galvanized steel or powder coated aluminium. Clear or opal polycarbonate diffuser.

Art	Watt	Type of light source	Luminous flux	Colour temperature	L70B50	Diffuser PC	Light control
860	-	E27	-	-	-	Opal	-
862	-	E27	-	-	-	Clear	-
866	8W	LED	451 lm	3000K	50 000h	Opal	Dim. Triac

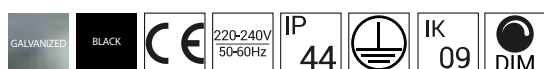
2700/4000K available by request, contact your supplier.







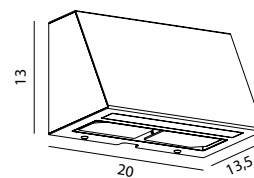
SKI



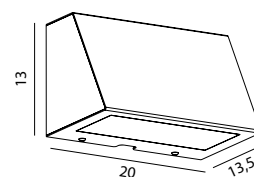
SKI Galvanized steel or galvanized and powder coated wall light. Transparent polycarbonate diffuser with structure.

Art	Watt	Type of light source	Luminous flux	Colour temperature	L70/B50	Light control	Connectors
1390	5,2W	LED	350 lm	3000K	70 000h	Dim. Triac	F (Schuko) 2x230V
1392	5,2W	LED	346 lm	3000K	70 000h	Dim. Triac	-
5113	5,2W	LED	432 lm	4000K	70 000h	Dim. Triac	-

2700/4000K available by request, contact your supplier.



Art. 1390

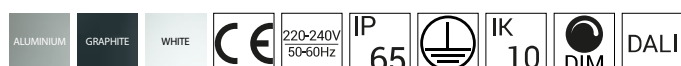


Art. 1392, 5113

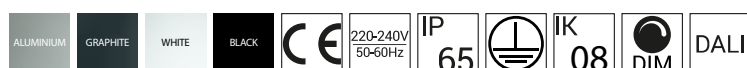


Photo: Swefor Jw

HALDEN

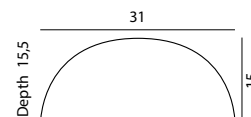


VASA



HALDEN Aluminium powder coated wall light. Supplied with transparent polycarbonate diffuser with structure.

Art	Watt	Type of light source	Luminous flux	Colour temperature	L70/B50	Version	Light control
510	-	E27	-	-	-	Down	-
515	8,5W	LED E27	175 lm	2700K	25 000h	Down	Dim. Triac
517	8,5W	LED	682 lm	3000K	50 000h	Down	Dim. Triac
5020*	8,5W	LED	662 lm	4000K	50 000h	Down	Dim. Triac
5097*	8,8W	LED	696 lm	4000K	50 000h	Down	DALI

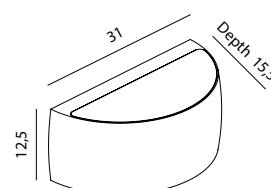


Art. 510
Art. 515
Art. 517
Art. 5020*
Art. 5097*



VASA Aluminium powder coated up & down wall light. Transparent polycarbonate diffuser with structure.

Art	Watt	Type of light source	Luminous flux	Colour temperature	L70/B50	Version	Light control
120	-	E27	-	-	-	Up & Down	-
127	8,5W	LED E27	384 lm	2700K	25 000h	Up & Down	Dim. Triac
128	8,5W	LED	581 lm	3000K	70 000h	Up & Down	Dim. Triac
5019*	8,5W	LED	668 lm	4000K	70 000h	Up & Down	Dim. Triac
5093	10,2W	LED	-	3000K	70 000h	Up & Down	DALI



Art. 120
Art. 127
Art. 128
Art. 5019*
Art. 5093



Art. 127/515: 8,5W LED E-27 bulb included, 806lm, 2700K, 25000h dimmable.

*2700/4000K available by request, contact your supplier.





PARIS

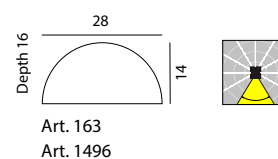
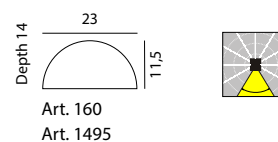


PARIS Galvanized steel or galvanized and powder coated wall light. Supplied with satin polycarbonate diffuser.

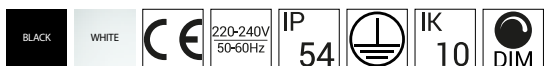
Art	Watt	Type of light source	Luminous flux	Colour temperature	L70/B50	Version	Light control
160	-	E27	-	-	-	Down	-
(Only Art. 160 can be made with copper)							
1495	5,2W	LED	430 lm	3000K	70 000h	Down	Dim. Triac
163	-	E27	-	-	-	Down	-
1496	5,2W	LED	417 lm	3000K	70 000h	Down	Dim. Triac

2700/4000K available by request, contact your supplier.

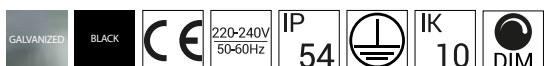
Copper: over time the copper will age naturally and acquire an antique brown patina.



BERLIN



BREMEN

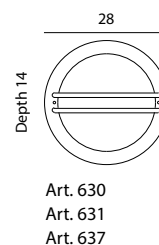
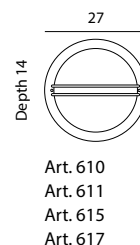


BERLIN Aluminium powder coated wall light. Supplied with clear or opal polycarbonate diffuser options.

Art	Watt	Type of light source	Luminous flux	Colour temperature	L70/B50	Diffuser	Light control
610	-	E27	-	-	-	Clear	-
611	-	E27	-	-	-	Opal	-
615	8,5W	LED E27	-	2700K	-	Opal	Dim. Triac
617	10W	LED	276 lm	3000K	50 000h	Opal	Dim. Triac

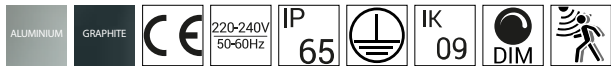
BREMEN Front cover is made of galvanized steel or painted steel and mounted on an aluminium backplate. Clear or opal polycarbonate diffuser.

Art	Watt	Type of light source	Luminous flux	Colour temperature	L70/B50	Diffuser	Light control
630	-	E27	-	-	-	Clear	-
631	-	E27	-	-	-	Opal	-
637	10W	LED	276 lm	3000K	50 000h	Opal	Dim. Triac

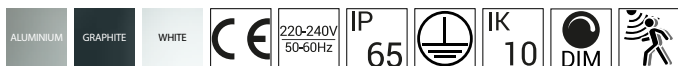


Art. 615: 8,5W LED E-27 bulb included, 806lm, 2700K, 25000h dimmable. 2700/4000K available by request, contact your supplier.

RONDANE



BORNHOLM



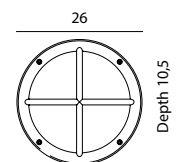
RONDANE Aluminium powder coated wall and ceiling light. Supplied with polycarbonate diffuser.

Art	Watt	Type of light source	Luminous flux	Colour temperature	L70/B50	Light control	Sensor HF
537	10W	LED	431 lm	3000K	50 000h	Dim. Triac	-
538	9W max	E27 LED	-	-	-	-	-
539	17,5W	LED	732 lm	3000K	50 000h	On/off	-
548	10W	LED	431 lm	3000K	50 000h	On/off	Yes

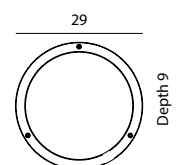
BORNHOLM Aluminium powder coated wall and ceiling light. Supplied with polycarbonate diffuser.

Art	Watt	Type of light source	Luminous flux	Colour temperature	L70/B50	Light control	Sensor HF
541	10W	LED	431 lm	3000K	50 000h	Dim. Triac	-
5121*	10W	LED	507 lm	4000K	50 000h	Dim. Triac	-
542	17,5W	LED	1039 lm	3000K	50 000h	On/off	-
5122*	17,5W	LED	1087 lm	4000K	50 000h	On/off	-
544	10W	LED	417 lm	3000K	50 000h	On/off	Yes

*2700/4000K or DALI available by request, contact your supplier.



Art. 537
Art. 538
Art. 539



Art. 541
Art. 542
Art. 5121*
Art. 5122*



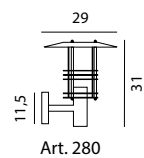
STOCKHOLM Galvanized steel or galvanized and powder coated wall light. Clear polycarbonate diffuser.

Art	Watt	Class	Type of light source	Diffuser: PC	Light control
280	-	II	E27	Clear	-
286 (Big)	-	II	E27	Clear	-

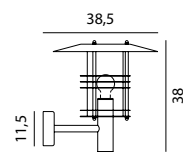
Accessories art. 280 i 286

153	Corner bracket	p. 130
159	Spacer	p. 130

Opal diffuser available as an option



Art. 280

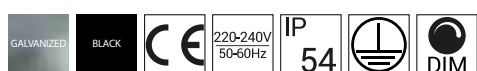


Art. 286

STOCKHOLM



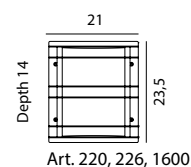
STOCKHOLM



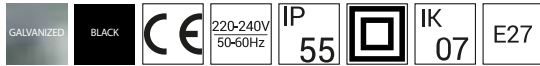
STOCKHOLM Aluminium backplate. Front in galvanized steel or galvanized steel and powder coated. Clear or opal polycarbonate diffuser.

Art	Watt	Type of light source	Luminous flux	Colour temperature	L70/B50	Diffuser: PC	Light control
220	-	E27	-	-	-	Opal	-
226	-	E27	-	-	-	Clear	-
1600	8W	LED	332 lm	3000K	50 000h	Opal	Dim. Triac

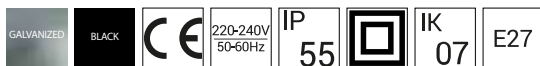
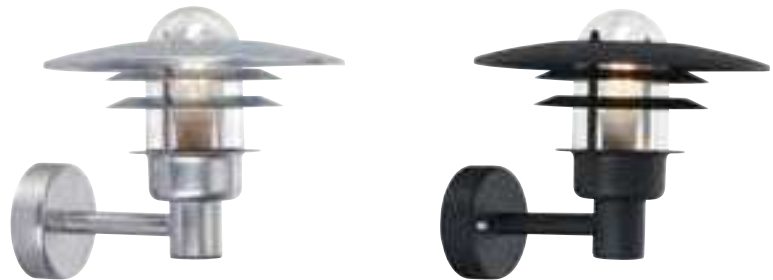
2700/4000K available by request, contact your supplier.



OSLO



LARVIK



OSLO Galvanized steel or galvanized and powder coated wall light. Clear polycarbonate diffuser.

Art	Watt	Class	Type of light source	Diffuser: PC	Light control
240	-	II	E27	Clear	-

Accessories Oslo Art. 240

153	Corner bracket	p. 130
159	Spacer	p. 130

(Satin diffuser available as an option)

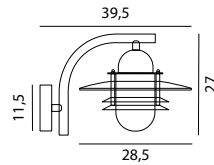
LARVIK Galvanized steel or galvanized and powder coated wall light. Clear polycarbonate diffuser.

Art	Watt	Class	Type of light source	Diffuser: PC	Light control
690	-	II	E27	Clear	-

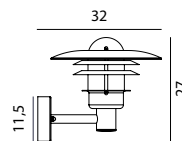
Accessories Larvik Art. 690

153	Corner bracket	p. 130
159	Spacer	p. 130

(Satin diffuser available as an option)



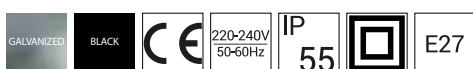
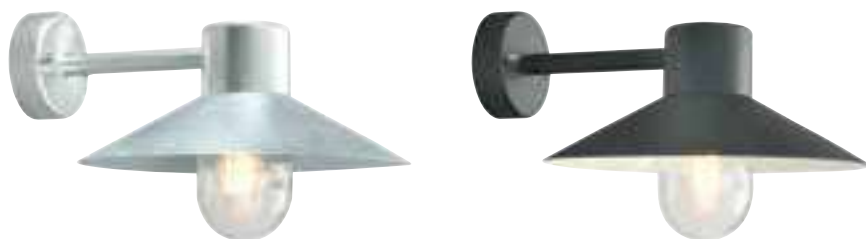
Art. 240



Art. 690



LUND



LUND Galvanized steel or galvanized and powder coated wall light. Clear polycarbonate diffuser.

Art	Watt	Class	Type of light source	Diffuser: PC	Light control
-----	------	-------	----------------------	--------------	---------------

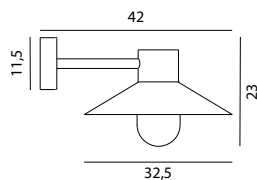
290	-	II	E27	Clear	-
-----	---	----	-----	-------	---

(Opal Diffuser available as an option)

Accessories Lund Art. 290

153	Corner bracket	p. 130
159	Spacer	p. 130

(Satin diffuser available as an option)



Art. 290



KARLSTAD



KARLSTAD Galvanized steel, copper or powder coated steel wall light. Clear polycarbonate diffuser.

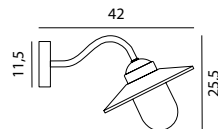
Art	Watt	Class	Type of light source	Diffuser: PC	Light control
230	-	II	E27	Clear	-

Accessories Karlstad Art. 230

153	Corner bracket	p. 130
159	Spacer	p. 130

(Satin diffuser available as an option)

Copper: over time the copper will age naturally and acquire an antique brown patina.



Art. 230

VANSBRO



BERGEN



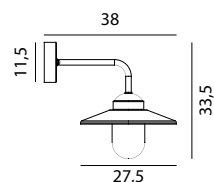
VANSBRO Galvanized steel, copper or powder coated steel wall light. Clear polycarbonate diffuser.

Art	Watt	Class	Type of light source	Diffuser: PC	Light control
1920	-	II	E27	Clear	-

Accessories Vansbro Art. 1920

153	Corner bracket	p. 130
159	Spacer	p. 130

(Satin diffuser available as an option)



Art. 1920

BERGEN Galvanized steel or galvanized and powder coated wall light. Clear polycarbonate diffuser.

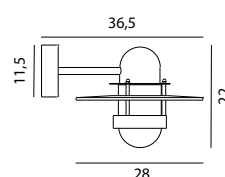
Art	Watt	Class	Type of light source	Diffuser: PC	Light control
270	-	II	E27	Clear	-

Accessories Bergen Art. 270

153	Corner bracket	p. 130
159	Spacer	p. 130

(Satin diffuser available as an option.)

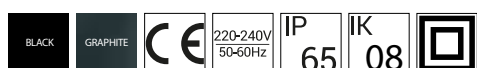
Copper: over time the copper will age naturally and acquire an antique brown patina.



Art. 270



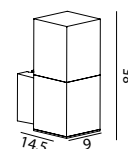
ARENDAL



ARENDAL Aluminium powder coated wall light. Supplied with tempered glass, frosted inside.

Art	Watt	Type of light source	Luminous flux	Colour temperature	L70/B50	Light control
1250	-	E14	-	-	-	-
1251	4W	LED	330 lm	3000K	50 000h	On/off

*2700/4000K available by request, contact your supplier.

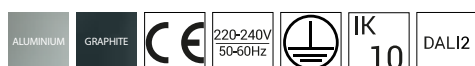


Art. 1250
Art. 1251



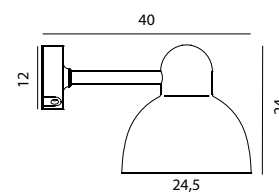


KOSTER



KOSTER Aluminium powder coated wall light. Supplied with transparent polycarbonate diffuser with structure.

Art	Watt	Type of light source	Luminous flux	Colour temperature	L70/B50	Ulor %	Light control	Lens
724	-	E27	-	-	-	0%	On/off	-
725	11,3W	LED	857 lm	3000K	50 000h	0%	On/off	-
1912	17,5W	LED	1568 lm	3000K	50 000h	0%	On/off	-
5004*	17,5W	LED	1625 lm	4000K	50 000h	0%	On/off	-
1810	14,4W	LED	1975 lm	3000K	>120 000h	0%	On/off	IESNA Version III
1814	14,4W	LED	1991 lm	3000K	>120 000h	0%	On/off	IESNA Version V
1830*	14,4W	LED	2045 lm	4000K	>120 000h	0%	On/off	IESNA Version III
1834*	14,4W	LED	2031 lm	4000K	>120 000h	0%	On/off	IESNA Version V
1818	19,4W	LED	2700 lm	3000K	>120 000h	0%	DALI2	IESNA Version III
1822	19,6W	LED	2747 lm	3000K	>120 000h	0%	DALI2	IESNA Version V
1838*	19,4W	LED	2732 lm	4000K	>120 000h	0%	DALI2	IESNA Version III
1842*	19,4W	LED	2718 lm	4000K	>120 000h	0%	DALI2	IESNA Version V



PRO
PRO
PRO
PRO
PRO
PRO
PRO

Accessories Koster

158 Corner bracket p. 130

* 2700/4000K available by request, contact your supplier.

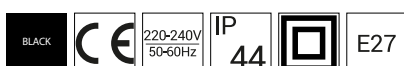


NEW



LOFOTEN

NEW

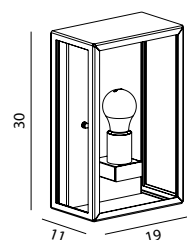


LOFOTEN Classic powder coated steel (electrogalvanized) wall fixtures with clear or opal glass.

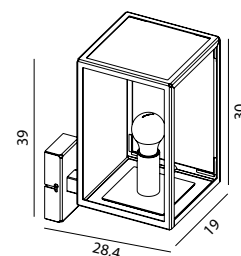
Art	Watt	Class	Type of light source	Light control	Version oprawy:	Glass:
1940	-	II	E27	-	Wall	Clear
1960	-	II	E27	-	Wall	Opal
1943	-	II	E27	-	Wall arm	Clear
1963	-	II	E27	-	Wall arm	Opal

Accessories for Lofoten

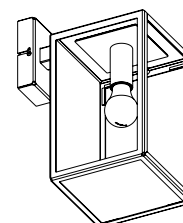
155	Corner bracket	p. 130	Art. 1943, 1963
-----	----------------	--------	-----------------



Art. 1940
Art. 1960



Art. 1943, Art. 1963







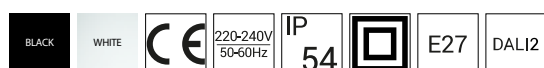
LONDON



LED



PRO



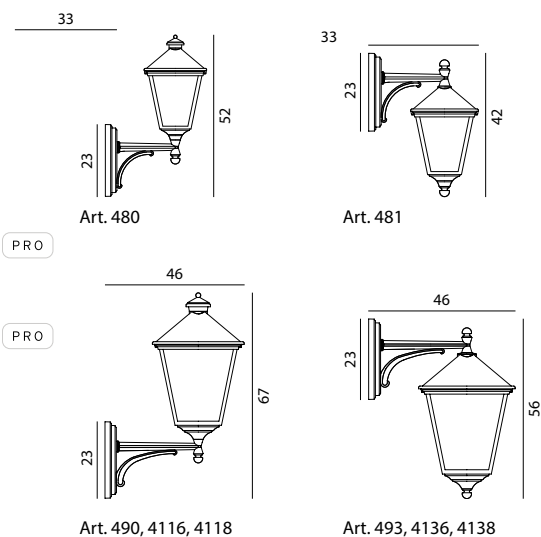
LONDON Aluminium powder coated wall lights. Supplied with transparent polycarbonate diffuser.

Art	Watt	Type of light source	Luminous flux	Colour temperature	L70/B50	Light control	Diffuser	Version
480	-	E27	-	-	-	-	-	Up
481	-	E27	-	-	-	-	-	Down
490	-	E27	-	-	-	-	-	Up
4116	9,5W	LED	757 lm	3000K	50 000h	On/off	-	Up
4118	19,4W	LED	2000 lm	3000K	>120 000h	DALI2	IESNA Type VS	Up
493	-	E27	-	-	-	-	-	Down
4136	9,5W	LED	757 lm	3000K	50 000h	On/off	-	Down
4138	19,4W	LED	2000 lm	3000K	>120 000h	DALI2	IESNA Type VS	Down

ACCESSORIES LONDON

152	Corner bracket	p.130
-----	----------------	-------

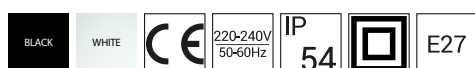
London LED with 2700/4000K available by request, contact your supplier.







MODENA

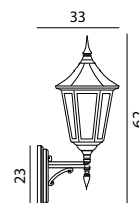


MODENA Aluminium powder coated wall lights. Transparent polycarbonate diffuser.

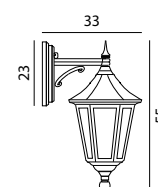
Art	Watt	Class	Type of light source	Diffuser: PC	Light control
350	-	II	E27	Clear	-
351	-	II	E27	Clear	-
380	-	II	E27	Clear	-
381	-	II	E27	Clear	-

Accessories for Modena Art. 350, 351, 380 i 381

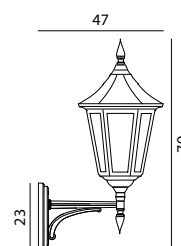
152	Corner bracket	p. 130
-----	----------------	--------



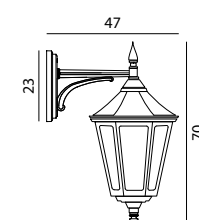
Art. 350



Art. 351

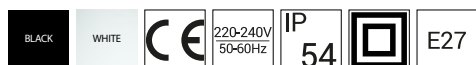


Art. 380

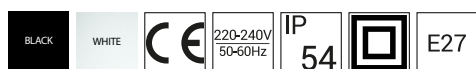


Art. 381

BOLOGNA

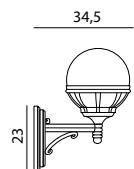


COMO

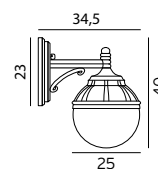


BOLOGNA Aluminium powder coated wall lights. Clear or opal PMMA globe.

Art	Watt	Class	Type of light source	Diffuser: PC	Light control
360	-	II	E27	Clear	-
361	-	II	E27	Opal	-
310	-	II	E27	Clear	-
311	-	II	E27	Opal	-



Art. 360, 361

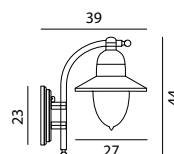


Art. 310, 311

COMO Aluminium powder coated wall light. Transparent polycarbonate diffuser.

Art	Watt	Class	Type of light source	Diffuser: PC	Light control
370	-	II	E27	Clear	-

(Opal diffuser available as an option).

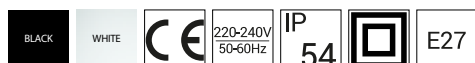


Art. 370

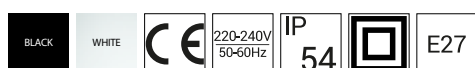
Accessories for Bologna Art. 310, 311, 360, 361 & Como Art. 370

152	Corner bracket	p. 130
-----	----------------	--------

RIMINI



FIRENZE



RIMINI Aluminium powder coated wall lights. Transparent polycarbonate diffuser.

Art	Watt	Class	Type of light source	Diffuser: PC	Light control
259	-	II	E27	Clear	-
2591	-	II	E27	Clear	-

Accessories for Rimini Art. 259, 2591

150	Corner bracket	p. 130
-----	----------------	--------

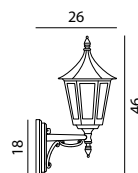
FIRENZE Aluminium powder coated wall light. Transparent polycarbonate diffuser.

Art	Watt	Class	Type of light source	Diffuser: PC	Light control
800	-	II	E27	Clear	-

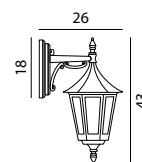
(Opal diffuser available as an option).

Accessories for Firenze Art. 800

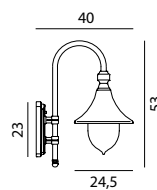
152	Corner bracket	p. 130
-----	----------------	--------



Art. 259



Art. 2591

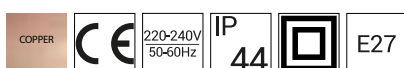


Art. 800





CHELSEA



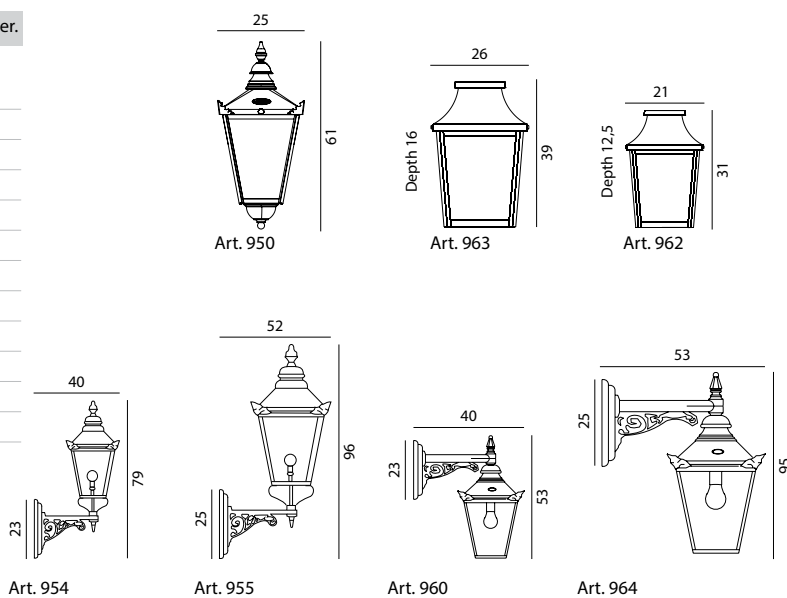
CHELSEA Handmade of copper and supplied with clear polycarbonate diffuser.

Art	Watt	Type of light source	Diffuser: PC	Light control
950	-	E27	Clear	-
962	-	E27	Clear	-
963	-	E27	Clear	-
954	-	E27	Clear	-
955 (Big)	-	E27	Clear	-
960	-	E27	Clear	-
964 (Big)	-	E27	Clear	-

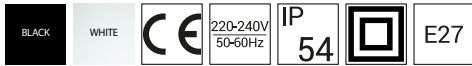
ACCESSORIES Chelsea

152	Corner bracket	p. 130	for Art. 954, 960
-----	----------------	--------	-------------------

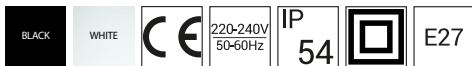
Copper fittings are supplied in a raw finish to allow natural patina over time.



GENOVA

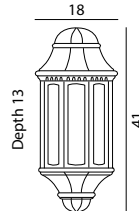


GENOVA MINI



GENOVA Aluminium powder coated wall light. Transparent polycarbonate diffuser.

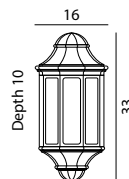
Art	Watt	Class	Type of light source	Diffuser: PC	Light control
170	-	II	E27	Clear	-



Art. 170

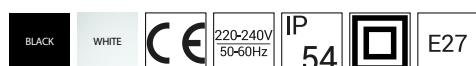
GENOVA MINI Aluminium powder coated wall light. Transparent polycarbonate diffuser.

Art	Watt	Class	Type of light source	Diffuser: PC	Light control
175	-	II	E27	Clear	-



Art. 175

GLASGOW

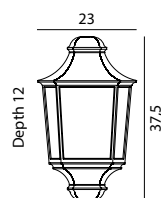


LONDON



GLASGOW Aluminium powder coated wall light. Transparent polycarbonate diffuser.

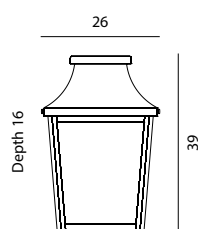
Art	Watt	Class	Type of light source	Diffuser: PC	Light control
730	-	II	E27	Clear	-



Art. 730

LONDON Aluminium powder coated wall light. Transparent polycarbonate diffuser.

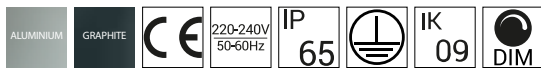
Art	Watt	Class	Type of light source	Diffuser: PC	Light control
497	-	II	E27	Clear	-



Art. 497



NAMSOS



NAMSOS MINI



NAMSOS Aluminium powder coated wall light. Supplied with tempered clear glass.

Art	Watt	Type of light source	Luminous flux	Colour temperature	L70/B50	Light control
1341	4W	LED	123 lm	3000K	>50 000h	Dim. Triac
5156*	4W	LED	162 lm	4000K	>50 000h	Dim. Triac

Accessories for Namsos Art. 1314, 5156

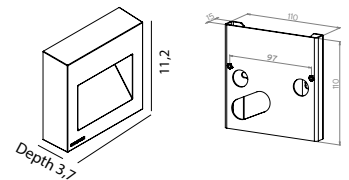
157	Spacer
-----	--------

NAMSOS MINI Recessed aluminium powder coated wall light. Supplied with tempered clear glass.

Art	Watt	Type of light source	Luminous flux	Colour temperature	L70/B50	Light control
1340	4W	LED	59 lm	3000K	>50 000h	Dim. Triac
5111*	4W	LED	63 lm	4000K	>50 000h	Dim. Triac

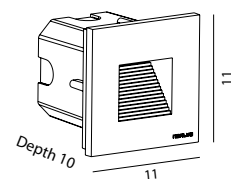
Included recessing box.

*2700/4000K available by request, contact your supplier.



Art. 1341
Art. 5156

Art. 157



Art. 1340
Art. 5111



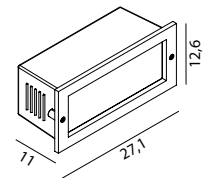
GRIMSTAD



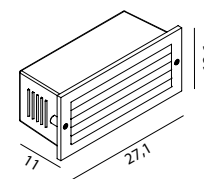
GRIMSTAD Recessed aluminium powder coated wall light. Supplied with tempered safety glass.

Art	Watt	Type of light source	Luminous flux	Colour temperature	L70/B50	Light control	Front
1544	5,2W	LED	285 lm	3000K	70 000h	Dim. Triac	Open
1546	-	E14	-	-	-	-	Open
1545	7,4W	LED	67 lm	3000K	60 000h	Dim. Triac	Covered
1547	-	E14	-	-	-	-	Covered

Included recessing box.
2700/4000K available by request, contact your supplier.

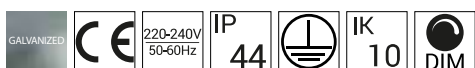


Art. 1544
Art. 1546

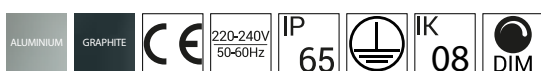


Art. 1545
Art. 1547

NAMSOS



NAMSOS



NAMSOS (GALVANIZED) Recessed aluminium powder coated wall light. Supplied with tempered safety glass.

Art	Watt	Type of light source	Luminous flux	Colour temperature	L70/B50	Light control
1933	5,2W	LED	295 lm	3000K	70 000h	Dim. Triac

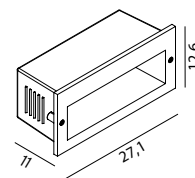
Included recessing box.

NAMSOS Recessed aluminium powder coated wall light. Supplied with tempered safety glass.

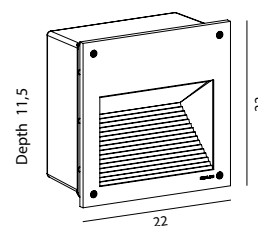
Art	Watt	Type of light source	Luminous flux	Colour temperature	L70/B50	Light control
1930	8,4W	LED	523 lm	3000K	50 000h	Dim. Triac
5011	8,7W	LED	576 lm	4000K	50 000h	Dim. Triac

Included recessing box.

2700/4000K or DALI available by request, contact your supplier.



Art. 1933



Art. 1930
Art. 5011*



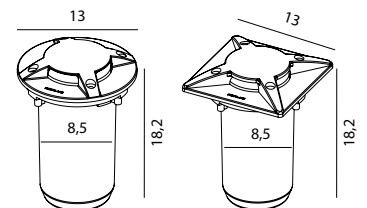
RENA COVER Aluminium powder coated inground lighting fixture. Supplied with opal polycarbonate diffuser.

Art	Watt	Type of light source	Luminous flux	Colour temperature	L70B50	Light control	Version
1630	-	LED GU10	-	-	-	-	Round
1631	5,5W	LED GU10	-	3000K	40 000h	Dim. Triac	Round
1768	4W	LED	439 lm	3000K	50 000h	Dim. Triac	Round
1770	8W	LED	839 lm	3000K	50 000h	Dim. Triac	Round
1632	-	LED GU10	-	-	-	-	Square
1633	5,5W	LED GU10	-	3000K	40 000h	Dim. Triac	Square
1772	4W	LED	439 lm	3000K	50 000h	Dim. Triac	Square
1774	8W	LED	839 lm	3000K	50 000h	Dim. Triac	Square

2700/4000K available by request, contact your supplier.

Polypropylene box for installation included. Standard with 3m cable, one cable gland. art. 1631, 1633: 5,5W GU10, 375lm, 3000K, 36D LED bulb included.

Art. 1630, 1632: Supplied without bulb



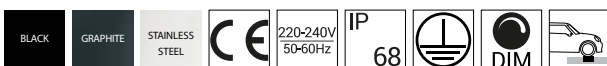
Art. 1630
Art. 1631

Art. 1632
Art. 1633





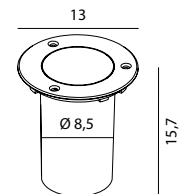
RENA



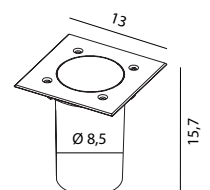
RENA Aluminium powder coated inground lighting fixture. Stainless steel 316L front and tempered safety clear or frosted glass.

Art	Watt	Type of light source	Luminous flux	Colour temperature	L70B50	Version	Diffuser:	Light control	Angle
1550	5,5W	LED GU10	-	3000K	40 000h	Round	Clear	Dim. Triac	36°
1552	-	LED GU10	-	-	-	Round	Clear	-	-
1554	5,5W	LED GU10	-	3000K	40 000h	Round	Frosted	Dim. Triac	36°
1556	-	LED GU10	-	-	-	Round	Frosted	-	-
1760	4W	LED	439 lm	3000K	50 000h	Round	Clear	Dim. Triac	36°
1764	8W	LED	839 lm	3000K	50 000h	Round	Clear	Dim. Triac	36°
1551	5,5W	LED GU10	-	3000K	40 000h	Square	Clear	Dim. Triac	36°
1553	-	LED GU10	-	-	-	Square	Clear	-	-
1555	5,5W	LED GU10	-	3000K	40 000h	Square	Frosted	Dim. Triac	36°
1557	-	LED GU10	-	-	-	Square	Frosted	-	-
1762	4W	LED	439 lm	3000K	50 000h	Square	Clear	Dim. Triac	36°
1766	8W	LED	839 lm	3000K	50 000h	Square	Clear	Dim. Triac	36°

2700/4000K available by request, contact your supplier. Polypropylene box for installation included.
 Standard with 3m cable, one cable gland. art. 1550, 1551, 1554, 1555: 5,5W GU10, 375lm, 3000K, 36D LED bulb included.
 Art. 1552, 1553, 1556, 1557: Supplied without bulb



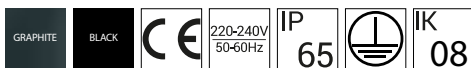
Art. 1550, 1552
 Art. 1554, 1556
 Art. 1760, 1764



Art. 1551, 1553
 Art. 1555, 1557
 Art. 1762, 1766



SANDE



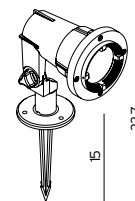
SANDE Aluminium powder coated landscape and shop lighting fixture. Adjustable head for tilting.

Art	Watt	Type of light source	Luminous flux	Colour temperature	L70/B50	Light control	Version
1592	5,5W	LED GU10	276 lm	3000K	40 000h	Dim. Triac	Ground / Wall
1593	8,6W	LED	652 lm	3000K	80 000h	On/off	Ground / Wall
1594	8,6W	LED	652 lm	3000K	80 000h	On/off	Ground
1598	5,5W	LED GU10	276 lm	3000K	40 000h	Dim. Triac	Ground

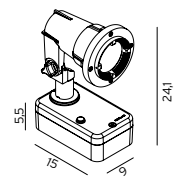
Accessories Sande

- 1233 Cap
- 1234 Spike for Art. 1594 & Art. 1598

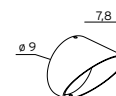
Art. 1592/1598: Symmetrical light with an angle of 36 degree.
 Art. 1593/1594: Symmetrical light with an angle of 40 degree.
 Art. 1592/1598: 5,5W LED GU10 bulb included, 375lm, 3000K, 40000h, 36D dimmable.
 2700/4000K available by request, contact your supplier.



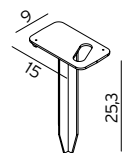
Art. 1592, 1593



Art. 1594, 1598



Art. 1233



Art. 1234

MOSS

NEW



MOSS MOVE

NEW

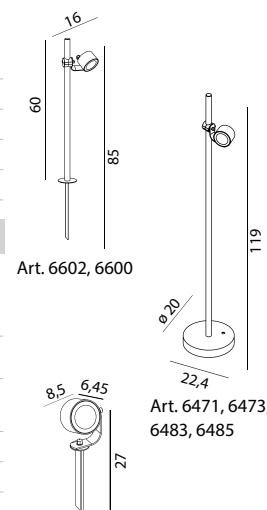


MOSS Aluminium powder coated ground lighting with safety glass. Adjustable head for tilting.

Art	Watt	Type of light source	Luminous flux	Colour temperature	L70/B50	Light control	Version	Angle
6165	4W	LED	439 lm	3000K	50 000h	Dim. Triac	Ground, 3m cable	36°
6167	8W	LED	839 lm	3000K	50 000h	Dim. Triac	Ground, 3m cable	36°
6602	4W	LED	439 lm	3000K	50 000h	Dim. Triac	Ground 60cm, 3m cable	36°
6600	8W	LED	839 lm	3000K	50 000h	Dim. Triac	Ground 60cm, 3m cable	36°

MOSS MOVE Aluminium powder coated and/or stainless steel ground lighting with safety glass. Adjustable head for tilting.

Art	Watt	Type of light source	Luminous flux	Colour temperature	L70/B50	Light control	Version	Angle
6483	8W	LED	439 lm	3000K	50 000h	Dim. Triac	Mobile, 5m cable with plug, stainless steel	36°
6485	4W	LED	839 lm	3000K	50 000h	Dim. Triac	Mobile, 5m cable with plug, stainless steel	36°
6471	8W	LED	439 lm	3000K	50 000h	Dim. Triac	Mobile, 5m cable with plug	36°
6473	4W	LED	839 lm	3000K	50 000h	Dim. Triac	Mobile, 5m cable with plug	36°



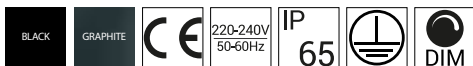
Art. 6165, 6167

2700/4000K available by request, contact your supplier.



MOSS

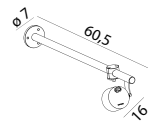
NEW



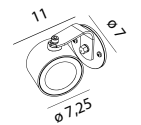
MOSS Aluminium powder coated ground lighting with safety glass. Adjustable head for tilting.

Art	Watt	Type of light source	Luminous flux	Colour temperature	L70/B50	Light control	Version	Angle
6161	4W	LED	439 lm	3000K	50 000h	Dim. Triac	Ground / Wall	36°
6163	8W	LED	839 lm	3000K	50 000h	Dim. Triac	Ground / Wall	36°
6772	4W	LED	439 lm	3000K	50 000h	Dim. Triac	Wall / Ground	36°
6778	8W	LED	839 lm	3000K	50 000h	Dim. Triac	Wall / Ground	36°
6706	4W	LED	439 lm	3000K	50 000h	Dim. Triac	Wall arm 60cm	36°
6702	8W	LED	839 lm	3000K	50 000h	Dim. Triac	Wall arm 60cm	36°

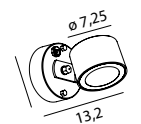
2700/4000K available by request, contact your supplier.
 Optionally available with symmetrical light with an angle of 15 or 24 degrees.



Art. 6706, 6702



Art. 6772, 6778

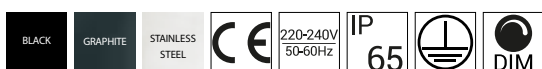


Art. 6161, 6163



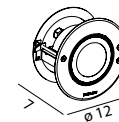
MOSS

NEW

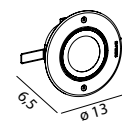


MOSS Aluminium powder coated and/or stainless steel ground lighting with safety glass. Adjustable head for tilting.

Art	Watt	Type of light source	Luminous flux	Colour temperature	L70/B50	Light control	Version	Angle
6732	4W	LED	439 lm	3000K	50 000h	Dim. Triac	Clamp for POLE Ø50	36°
6735	4W	LED	439 lm	3000K	50 000h	Dim. Triac	Clamp for POLE Ø60	36°
6738	4W	LED	439 lm	3000K	50 000h	Dim. Triac	Clamp for POLE Ø76	36°
6750	8W	LED	839 lm	3000K	50 000h	Dim. Triac	Clamp for POLE Ø50	36°
6753	8W	LED	839 lm	3000K	50 000h	Dim. Triac	Clamp for POLE Ø60	36°
6756	8W	LED	839 lm	3000K	50 000h	Dim. Triac	Clamp for POLE Ø76	36°
6346	4W	LED	439 lm	3000K	50 000h	Dim. Triac	Recessed in ceiling, screw, Ø120, stainless steel	36°
6370	8W	LED	839 lm	3000K	50 000h	Dim. Triac	Recessed in ceiling, screw, Ø120, stainless steel	36°
6355	4W	LED	439 lm	3000K	50 000h	Dim. Triac	Recessed in ceiling, spring, Ø130	36°
6379	8W	LED	839 lm	3000K	50 000h	Dim. Triac	Recessed in ceiling, spring, Ø130	36°



Art. 6346, 6370



Art. 6355, 6379



Art. 6732, 6735, 6738, 6750, 6753, 6756

2700/4000K available by request, contact your supplier.

Optionally available with symmetrical light with an angle of 15 or 24 degrees.



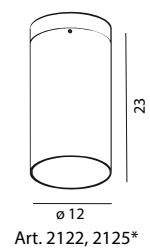
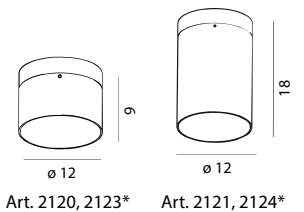
NIDAROS

NEW



NIDAROS Aluminium powder coated ceiling light. Supplied with transparent safety glass.

Art	Watt	Type of light source	Luminous flux	Colour temperature	L70B50	Light control	Height	Angle
2120	10,7W	LED	631 lm	3000K	50 000h	Dim. Triac	9cm	24°
2121	8,3W	LED	631 lm	3000K	50 000h	Dim. Triac	18cm	24°
2122	8,3W	LED	631 lm	3000K	50 000h	Dim. Triac	23cm	24°
2123*	10,7W	LED	631 lm	4000K	50 000h	Dim. Triac	9cm	24°
2124*	8,3W	LED	631 lm	4000K	50 000h	Dim. Triac	18cm	24°
2125*	8,3W	LED	631 lm	4000K	50 000h	Dim. Triac	23cm	24°



*2700/4000K available by request, contact your supplier.



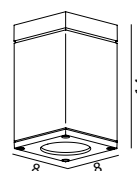
SANDVIK



SANDVIK Aluminium powder coated ceiling light. Supplied with transparent safety glass.

Art	Watt	Type of light source	Luminous flux	Colour temperature	L70B50	Version	Light control
795	max 4W	LED GU10	-	-	-	Down	-
796	3,9W	LED GU10	477 lm	2700K	40 000h	Down	Dim. Triac

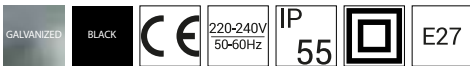
Art. 796: 3,9W LED GU10 bulb included, 265lm, 2700K, 40000h, 25D dimmable



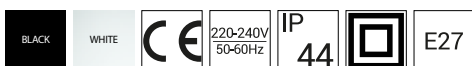
Art. 795 i 796



BERGEN



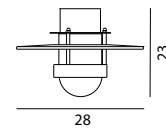
LATINA



BERGEN Galvanized steel or galvanized and powder coated wall light. Clear polycarbonate

Art	Watt	Class	Type of light source	Diffuser: PC	Light control
271	-	II	E27	Clear	-

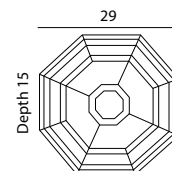
(Satin diffuser available as an option)



Art. 271

LATINA Aluminium powder coated wall light. Supplied with transparent polycarbonate diffuser with structure.

Art	Watt	Class	Type of light source	Diffuser: PC	Version	Light control
105	-	II	E27	Structure	Wall / Ceiling	-

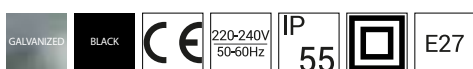


Art. 105

KARLSTAD



OSLO



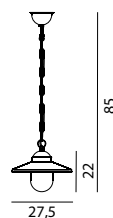
KARLSTAD Galvanized steel or galvanized and powder coated wall light. Clear polycarbonate diffuser.

Art	Watt	Class	Type of light source	Diffuser: PC	Light control
230A	-	II	E27	Clear	-

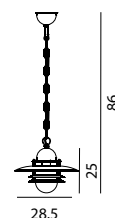
OSLO Galvanized steel or galvanized and powder coated wall light. Clear polycarbonate diffuser.

Art	Watt	Class	Type of light source	Diffuser: PC	Light control
240A	-	II	E27	Clear	-

Satin diffuser available as an option

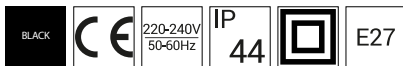


Art. 230A



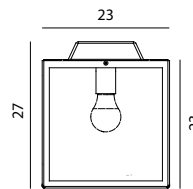
Art. 240A

LOFOTEN

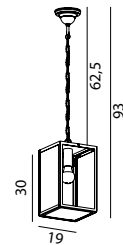


LOFOTEN Classic powder coated steel (electrogalvanized)wall fixtures with clear glass.

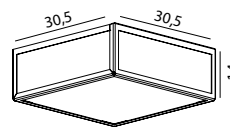
Art	Watt	Class	Type of light source	Diffuser: PC	Light control
1942	-	II	E27	Clear	-
1944	-	II	E27	Clear	-
1945	-	II	2 x E27	Clear	-



Art. 1942



Art. 1944

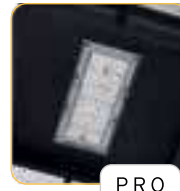


Art. 1945

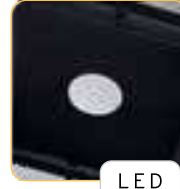
LONDON



NEW



PRO



LED



BLACK
WHITE
CE
220-240V 50-60Hz
IP 54
E27
DALI2

CHELSEA



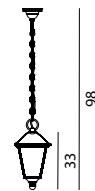
COPPER
CE
220-240V 50-60Hz
IP 44
E27

LONDON Aluminium powder coated ceiling lights. Supplied with transparent polycarbonate diffuser.

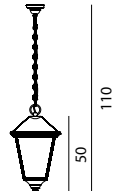
Art	Watt	Type of light source	Luminous flux	Colour temperature	L70/B50	Light control	Lens
481A	-	E27	-	-	-	-	-
493A	-	E27	-	-	-	-	-
4140	17,5W	LED	1392 lm	3000K	50 000h	On/off	-
4142	19,4W	LED	2000 lm	3000K	>120 000h	DALI2	IESNA Type VS

PRO

2700/4000K available by request, contact your supplier.



Art. 481A

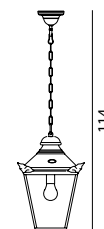


Art. 493A
Art. 4140*
Art. 4142*

CHELSEA Handmade of copper and supplied with clear polycarbonate diffuser.

Art	Watt	Class	Type of light source	Diffuser: PC	Light control
961	-	II	E27	Clear	-

Copper fittings are supplied in a raw finish to allow natural patina over time.

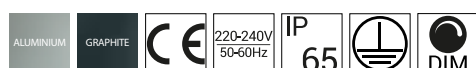


Art. 961





STAVANGER

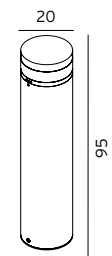


STAVANGER Powder coated aluminium bollard. diffuser: UV stabilised, vandal resistant. Indirect LED light output.

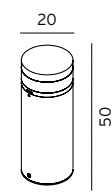
Art	Watt	Type of light source	Luminous flux	Colour temperature	L70/B50	Height	Light control	Diffuser	IK
1240	12,2W	LED	421 lm	3000K	50 000h	95cm	Dim. Triac	PC Clear	IK10
1243	-	E27	-	-	-	95cm	-	PMMA Frosted	
5008*	12,2W	LED	493 lm	4000K	50 000h	95cm	Dim. Triac	PC Clear	IK10
1244	12,2W	LED	421 lm	3000K	50 000h	50cm	Dim. Triac	PC Clear	IK10
1246	-	E27	-	-	-	50cm	-	PMMA Frosted	
5009*	12,2W	LED	-	4000K	50 000h	50cm	Dim. Triac	PC Clear	IK10
1247	8,4W	LED	308 lm	3000K	50 000h	28cm	Dim. Triac	PC Clear	IK10
1248	-	E27	-	-	-	28cm	-	PMMA Frosted	
5010*	8,4W	LED	351 lm	4000K	50 000h	28cm	Dim. Triac	PC Clear	IK10

ACCESSORIES Stavanger

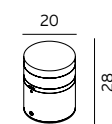
1230	Concreting anchor	p. 131
1231	Anchoring support	p. 131



Art. 1240
Art. 1243
Art. 5008*



Art. 1244
Art. 1246
Art. 5009*



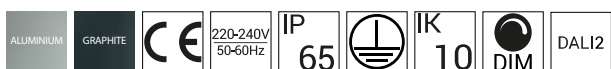
Art. 1247
Art. 1248
Art. 5010*

*2700/4000K or DALI2 available by request, contact your supplier.



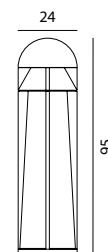
Photo: Sömsnads fotograf

NARVIK



NARVIK Powder coated aluminium vandal resistant. Polycarbonate transparent or frosted diffuser. Inspection door.

Art	Watt	Type of light source	Luminous flux	Colour temperature	L70/B50	Light control	Diffuser
557	21,8W	LED	556 lm	3000K	>50 000h	On/off	Clear
5024	21,8W	LED	564 lm	4000K	>50 000h	On/off	Clear
5090*	21,8W	LED	582 lm	4000K	>50 000h	DALI2	Clear
5091*	22,5W	LED	597 lm	3000K	>50 000h	DALI2	Clear
553	15W	LED	800 lm	3000K	>72 000h	Dim. Triac	Clear
559	15W	LED	800 lm	3000K	>72 000h	Dim. Triac	Frosted
5094*	15W	LED	800 lm	4000K	>72 000h	Dim. Triac	Clear
5095*	15W	LED	800 lm	4000K	>72 000h	Dim. Triac	Frosted



ACCESSORIES Narvik

505 Concreting anchor p. 131

*2700/4000K available by request, contact your supplier.



Photo: Stenstads Høydrafoto

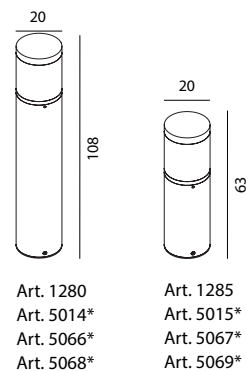
EGERSUND Powder coated aluminium bollard. Clear PMMA diffuser. Indirect LED light output.

Art	Watt	Type of light source	Luminous flux	Colour temperature	L70/B50	Height	Light control
1280	22W	LED	1586 lm	3000K	50 000h	108cm	On/off
5014*	22W	LED	1801 lm	4000K	50 000h	108cm	On/off
5066*	23W	LED	1724 lm	4000K	50 000h	108cm	DALI2
5068*	23W	LED	1586 lm	3000K	50 000h	108cm	DALI2
<hr/>							
1285	22W	LED	1586 lm	3000K	50 000h	65cm	On/off
5015*	22W	LED	1801 lm	4000K	50 000h	65cm	On/off
5067*	23W	LED	1724 lm	4000K	50 000h	65cm	DALI2
5069*	23W	LED	1586 lm	3000K	50 000h	65cm	DALI2

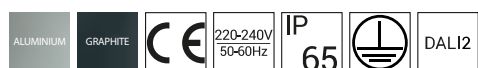
Accessories Egersund

1230	Concreting anchor	p. 131
1231	Anchoring support	p. 131

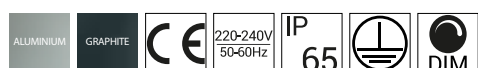
*2700/4000K available by request, contact your supplier.



EGERSUND



EGERSUND MINI



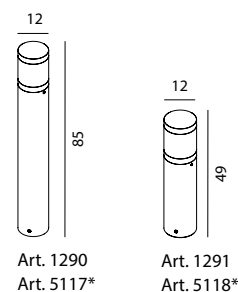
EGERSUND MINI Powder coated aluminium bollard. Clear PMMA diffuser. Indirect LED light output.

Art	Watt	Type of light source	Luminous flux	Colour temperature	L70/B50	Height	Light control
1290	10W	LED	864 lm	3000K	50 000h	85cm	Dim. Triac
5117*	10W	LED	922 lm	4000K	50 000h	85cm	Dim. Triac
1291	10W	LED	864 lm	3000K	50 000h	49cm	Dim. Triac
5118*	10W	LED	922 lm	4000K	50 000h	49cm	Dim. Triac

Accessories Egersund Mini

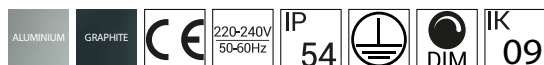
205	Concreting anchor	p. 130
206	Anchoring support	p. 130

* 2700/4000K available by request, contact your supplier.



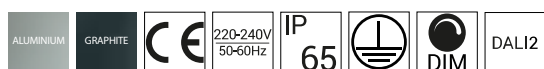


OPPLAND



KISA

NEW



OPPLAND Powder coated aluminium bollard. Diffuser: UV stabilised polycarbonate. Indirect LED light output.

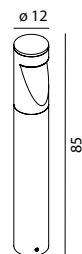
Art	Watt	Type of light source	Luminous flux	Colour temperature	L70/B50	Light control
1321	9,3W	LED	301 lm	3000K	>50000h	Dim. Triac
5123	9,3W	LED	322 lm	4000K	>50000h	Dim. Triac

KISA Powder coated aluminium bollard. Diffuser: PMMA frosted.

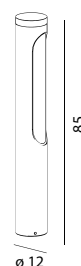
Art	Watt	Type of light source	Luminous flux	Colour temperature	L70/B50	Light control	Version
5180	8,8W	LED	706 lm	3000K	>70 000h	Dim. Triac	One-sided light
5181	8,8W	LED	701 lm	3000K	>70 000h	On/off	One-sided light
5182	14,1W	LED	1185 lm	3000K	>70 000h	DALI2	One-sided light
5183	14,2W	LED	1222 lm	4000K	>70 000h	DALI2	One-sided light
5184	15,2W	LED	1407 lm	3000K	>70 000h	Dim. Triac	Two-sided light
5185	15,2W	LED	1492 lm	4000K	>70 000h	On/off	Two-sided light
5186	27W	LED	2432 lm	3000K	>70 000h	DALI2	Two-sided light
5187	27W	LED	2579 lm	4000K	>70 000h	DALI2	Two-sided light

ACCESSORIES Oppland i Kisa

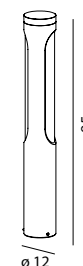
205	Concreting anchor	p. 130	*2700/4000K available by request, contact your supplier.
206	Anchoring support	p. 130	



Art. 132, 5123



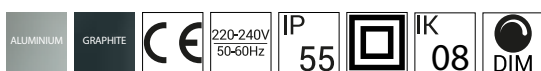
Art. 5180, 5181, 5182, 5183



Art. 5184, 5185, 5186, 5187



LILLESAND



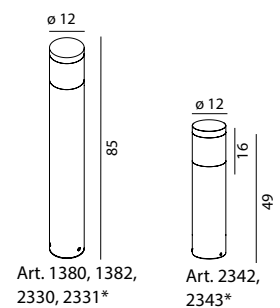
LILLESAND Powder coated aluminium bollard. Frosted PMMA diffuser.

Art	Watt	Type of light source	Luminous flux	Colour temperature	L70/B50	Height	Light control
1380	-	E27	-	-	-	85cm	-
1382	-	LED E27	-	2700K	25 000h	85cm	Dim. Triac
2330	9,3W	LED	897 lm	3000K	>72 000h	85cm	Dim. Triac
2331*	9,3W	LED	957 lm	4000K	>72 000h	85cm	Dim. Triac
2342	9,3W	LED	897 lm	3000K	>72 000h	49cm	Dim. Triac
2343*	9,3W	LED	957 lm	4000K	>72 000h	49cm	Dim. Triac

ACCESSORIES Lillesand

205	Concreting anchor	p. 130
206	Anchoring support	p. 130

Art. 1382: 8,5W LED E27 bulb included, 806lm, 2700K, 25000h dimmable. 2700/4000K or DALI2 available by request, contact your supplier.





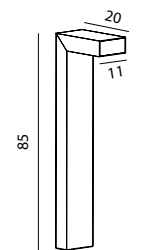
ASKER



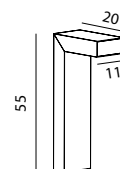
ASKER Aluminium powder coated bollard. Supplied with transparent polycarbonate diffuser with structure.

Art	Watt	Type of light source	Luminous flux	Colour temperature	L70/B50	Light control	Lens	Height
1310	9,5W	LED	585 lm	3000K	50 000h	On/off	-	55cm
1311	10,3W	LED	537 lm	3000K	50 000h	On/off	-	85cm
1314	7,7W	LED	697 lm	3000K	>109 000h	Dim. Triac	IESNA Type II/III	85cm
1315	7,8W	LED	683 lm	3000K	>109 000h	DALI	IESNA Type II/III	85cm
1316	7,7W	LED	604 lm	3000K	>109 000h	Dim. Triac	IESNA Type V	85cm
1317	7,8W	LED	599 lm	3000K	>109 000h	DALI	IESNA Type V	85cm
1318*	7,7W	LED	724 lm	4000K	>109 000h	Dim. Triac	IESNA Type II/III	85cm
1319*	7,8W	LED	706 lm	4000K	>109 000h	DALI	IESNA Type II/III	85cm
1320*	7,7W	LED	617 lm	4000K	>109 000h	Dim. Triac	IESNA Type V	85cm
1322*	7,8W	LED	616 lm	4000K	>109 000h	DALI	IESNA Type V	85cm
5120*	9,5W	LED	636 lm	4000K	50 000h	On/off	-	55cm
5124*	9,5W	LED	640 lm	4000K	50 000h	On/off	-	85cm

PRO
PRO
PRO
PRO
PRO
PRO



Art. 1311, 1312, 1314, 1315, 1316, 1317, 1318, 1319, 1320, 1322, 5124



Art. 1310, 5120

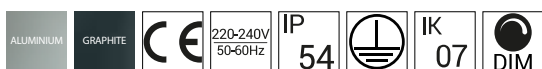
Accessories for Asker Art. 1311 i 1314

1907	Concreting anchor	p. 131
1908	Anchoring support	p. 131

*2700/4000K available by request, contact your supplier.



MOLDE



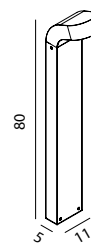
MOLDE Aluminium powder coated bollard. Supplied with transparent polycarbonate diffuser with structure.

Art	Watt	Type of light source	Luminous flux	Colour temperature	L70/B50	Height	Light control
1901	8W	LED	386 lm	3000K	50 000h	80cm	Dim. Triac
5107*	8W	LED	386 lm	4000K	50 000h	80cm	Dim. Triac

ACCESSORIES Molde Art. 1901

1907	Concreting anchor	p. 131
1908	Anchoring support	p. 131

* 2700/4000K available by request, contact your supplier.





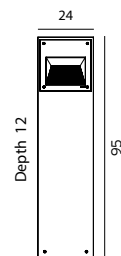
NAMSOS Aluminium powder coated bollard. Supplied with tempered safety glass.

Art	Watt	Type of light source	Luminous flux	Colour temperature	L70/B50	Height	Light control
1931	8,4W	LED	523 lm	3000K	>50 000h	95cm	Dim. Triac
5012*	8,4W	LED	557 lm	4000K	>50 000h	95cm	Dim. Triac
1932	8,4W	LED	523 lm	3000K	>50 000h	65cm	Dim. Triac
5013*	8,4W	LED	557 lm	4000K	>50 000h	65cm	Dim. Triac

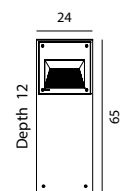
ACCESSORIES Namsos for Art. 1931 i 1932

112	Concreting anchor	p. 130
113	Anchoring support	p. 130

* 2700/4000K available by request, contact your supplier.



Art. 1931
Art. 5012*



Art. 1932
Art. 5013*

NAMSOS



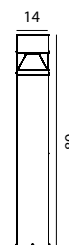
ARVIKA



ARVIKA Galvanized steel or galvanized and powder coated. Supplied with clear polycarbonate glass.								
Art	Watt	Type of light source	Luminous flux	Colour temperature	L70/B50	Height	Light control	Connectors
891	12,7W	LED	593 lm	3000K	72 000h	89cm	On/off	-
893	12,7W	LED	593 lm	3000K	72 000h	89cm	On/off	F (Schuko) 2x230V
898	-	E27	-	-	-	89cm	-	-
899	-	E27	-	-	-	89cm	-	F (Schuko) 2x230V
Accessories Arvika								
208	Concreting anchor			p. 131				

Arvika 893/899 is delivered with two F type (shuko), automatic fuses and circuit breaker. Art. 893/899 are not intended for charging EI/hybrid cars or for use on piers near the sea. Any use mentioned above results in the complete loss of all warranty and liability claims of the buyer.

2700/4000K available by request, contact your supplier.



Art. 891
Art. 893
Art. 898
Art. 899

HELLVIK

NEW



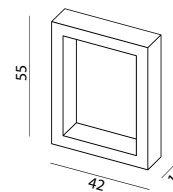
HELLVIK Aluminium powder coated bollard. Supplied with transparent polycarbonate diffuser with structure.

Art	Watt	Type of light source	Luminous flux	Colour temperature	L70/B50	Light control	Height
2400	6,9W	LED	531 lm	3000K	>72 000h	Dim. Triac	55cm
2401*	6,9W	LED	575 lm	4000K	>72 000h	Dim. Triac	55cm
2410	11,8W	LED	1014 lm	3000K	>72 000h	Dim. Triac	85cm
2411*	11,8W	LED	1072 lm	4000K	>72 000h	Dim. Triac	85cm

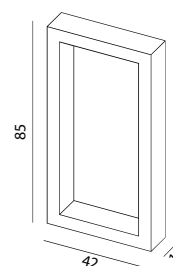
ACCESSORIES Hellvik

1907	Concreting anchor (2 pcs needed)				p. 131
1908	Anchoring support (2 pcs needed)				p. 131

* 2700/4000K available by request, contact your supplier.



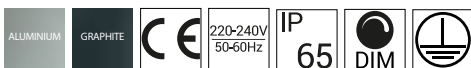
Art. 2400, 2401



Art. 2410, 2411

BORG

NEW



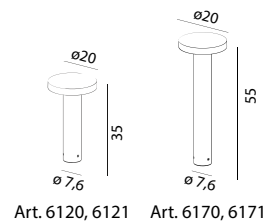
BORG Powder coated aluminium bollard. Frosted PMMA diffuser.

Art	Watt	Type of light source	Luminous flux	Colour temperature	L70/B50	Light control	Height
6120	16,1W	LED	1358 lm	3000K	>72 000h	Dim. Triac	35cm
6121*	16W	LED	1396 lm	4000K	>72 000h	Dim. Triac	35cm
6170	16,1W	LED	1358 lm	3000K	>72 000h	On/off	55cm
6171*	16W	LED	1396 lm	4000K	>72 000h	Dim. Triac	55cm
6180	16,1W	LED	1358 lm	3000K	>72 000h	On/off	85cm
6181*	16W	LED	1396 lm	4000K	>72 000h	Dim. Triac	85cm
6190	16W	LED	1358 lm	3000K	>72 000h	Dim. Triac	105cm
6191*	16W	LED	1396 lm	4000K	>72 000h	Dim. Triac	105cm

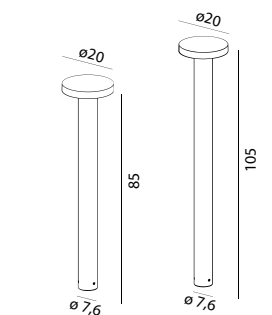
ACCESSORIES Borg

202	Anchoring support	p. 131
203	Concreting anchor	p. 130

* 2700/4000K available by request, contact your supplier.



Art. 6120, 6121 Art. 6170, 6171

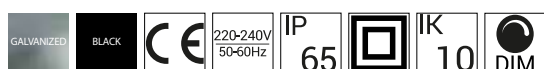


Art. 6180, 6181 Art. 6190, 6191





ALTA



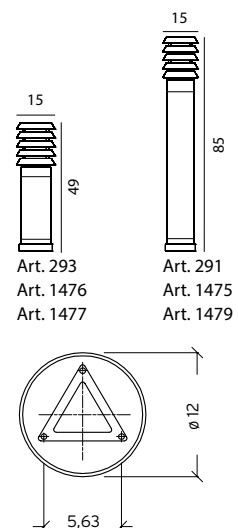
ALTA Heavy duty galvanized steel or galvanized and powder coated bollard with opal polycarbonate diffuser.

Art	Watt	Class	Type of light source	Luminous flux	Colour temperature	L70/B50	Height	Light control
291	-	II	E27	-	-	-	85cm	-
1475	8,5W	II	LED E27	-	2700K	25 000h	85cm	Dim. Triac
1479	10W	I	LED	146 lm	3000K	50 000h	85cm	Dim. Triac
293	-	II	E27	-	-	-	49cm	-
1476	8,5W	II	LED E27	-	2700K	25 000h	49cm	Dim. Triac
1477	10W	I	LED	146 lm	3000K	50 000h	49cm	Dim. Triac

ACCESSORIES Alta

205	Concreting anchor	p. 130
206	Anchoring support	p. 130

Art. 1475/1477: 8,5W LED E27 included, 806lm, 2700K, 25000h dimmable. 2700/4000K or DALI available by request, contact your supplier.





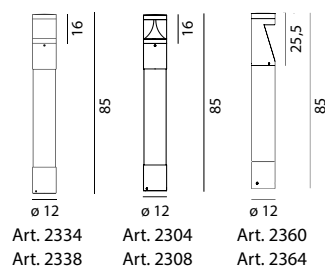
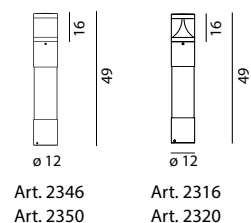
SCANDINAVIAN WOOD

NEW



SCANDINAVIAN WOOD Our wooden bollards combining modern lighting in harmony with natural materials.

Art	Watt	Type of light source	Luminous flux	Colour temperature	L70/B50	Light control	Wood	Height	Model
2304	9,1W	LED	864 lm	3000K	72 000h	Dim. Triac	painted	85cm	Egersund Mini
2308	9,1W	LED	864 lm	3000K	72 000h	Dim. Triac	impregnated	85cm	Egersund Mini
2316	9,1W	LED	864 lm	3000K	72 000h	Dim. Triac	painted	49cm	Egersund Mini
2320	9,1W	LED	864 lm	3000K	72 000h	Dim. Triac	impregnated	49cm	Egersund Mini
2334	9,1W	LED	897 lm	3000K	72 000h	Dim. Triac	painted	85cm	Lillesand
2338	9,1W	LED	897 lm	3000K	72 000h	Dim. Triac	impregnated	85cm	Lillesand
2346	9,1W	LED	897 lm	3000K	72 000h	Dim. Triac	painted	49cm	Lillesand
2350	9,1W	LED	897 lm	3000K	72 000h	Dim. Triac	impregnated	49cm	Lillesand
2360	10W	LED	301 lm	3000K	>50 000h	Dim. Triac	painted	85cm	Oppland
2364	10W	LED	301 lm	3000K	>50 000h	Dim. Triac	impregnated	85cm	Oppland



Accessories Scandinavian Wood

205	Concreting anchor	p. 130
206	Anchoring support	p. 130

2700/4000K or DALI2 available by request, contact your supplier.
We use a selection of first class Scandinavian pine wood, impregnated for protection.
Impregnated only: without painting on request to allow customized colours.

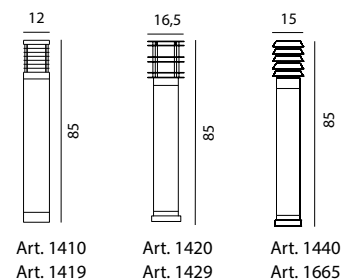
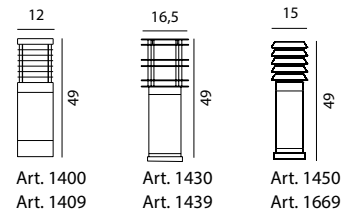


SCANDINAVIAN WOOD Our wooden bollards combining modern lighting in harmony with natural materials.

Art	Watt	Type of light source	Luminous flux	Colour temperature	L70/B50	Light control	Wood	Height	Model
1400	-	E27	-	-	-	-	painted	49cm	Halmstad
1409	8,5W	LED	292lm	3000K	>50 000h	Dim. Triac	painted	49cm	Halmstad
1410	-	E27	-	-	-	-	painted	85cm	Halmstad
1419	8,5W	LED	292lm	3000K	>50 000h	Dim. Triac	painted	85cm	Halmstad
1420	-	E27	-	-	-	-	painted	85cm	Stockholm
1429	8,4W	LED	342lm	3000K	>50 000h	Dim. Triac	painted	85cm	Stockholm
1430	-	E27	-	-	-	-	painted	49cm	Stockholm
1439	8,4W	LED	342lm	3000K	>50 000h	Dim. Triac	painted	49cm	Stockholm
1440	-	E27	-	-	-	-	painted	85cm	Alta
1450	-	E27	-	-	-	-	painted	49cm	Alta
1665	8,3W	LED	146lm	3000K	>50 000h	Dim. Triac	painted	85cm	Alta
1669	8,3W	LED	146lm	3000K	>50 000h	Dim. Triac	painted	49cm	Alta

Accessories Scandinavian Wood

205	Concreting anchor	p. 130
206	Anchoring support	p. 130



2700/4000K available by request, contact your supplier.
We use a selection of first class Scandinavian pine wood, impregnated for protection.
Impregnated only: without painting on request to allow customized colours.



HALMSTAD



HALMSTAD Heavy duty galvanized steel or galvanized and powder coated bollard with opal polycarbonate diffuser.

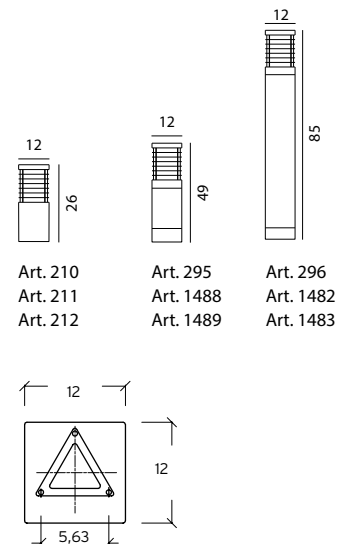
Art	Watt	Class	Type of light source	Luminous flux	Colour temperature	L70/B50	Height	Light control
210	-	II	E27	-	-	-	26cm	-
212	8,5W	II	LED E27	-	2700K	25 000h	26cm	Dim. Triac
211	10W	I	LED	295 lm	3000K	50 000h	26cm	Dim. Triac
295	-	II	E27	-	-	-	49cm	-
1488	8,5W	II	LED E27	-	2700K	25 000h	49cm	Dim. Triac
1489	8,5W	II	LED	292 lm	3000K	50 000h	49cm	Dim. Triac
296	-	II	E27	-	-	-	85cm	-
1483	8,5W	II	LED E27	-	2700K	25 000h	85cm	Dim. Triac
1482	8,5W	II	LED	292 lm	3000K	50 000h	85cm	Dim. Triac

Accessories Halmstad

205 Concreting anchor p. 130

206 Anchoring support p. 130

Art. 212/1488/1483: 8,5W LED E27 included, 806lm, 2700K, 25000h dimmable. 2700/4000K or DALI available by request, contact your supplier.





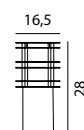
STOCKHOLM Heavy duty galvanized steel or galvanized and powder coated bollard with opal polycarbonate diffuser.

Art	Watt	Class	Type of light source	Luminous flux	Colour temperature	L70/B50	Diffuser	Height	Light control
299	-	II	E27	-	-	-	Opal	28cm	-
1269	8,5W	II	LED E27	-	2700K	25 000h	Opal	28cm	Dim. Triac
1268	10W	I	LED	333 lm	3000K	50 000h	Opal	28cm	Dim. Triac
289	-	II	E27	-	-	-	Opal	49cm	-
298	-	II	E27	-	-	-	Clear	49cm	-
1469	8,5W	II	LED E27	294 lm	2700K	25 000h	Opal	49cm	Dim. Triac
1260	8,5W	II	LED	342 lm	3000K	50 000h	Opal	49cm	Dim. Triac

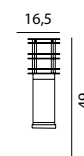
ACCESSORIES Stockholm

205	Concreting anchor	p. 130
206	Anchoring support	p. 130

Art. 1269/1469: 8,5W LED E27 included, 806lm, 2700K, 25000h dimmable.
2700/4000K or DALI available by request, contact your supplier.

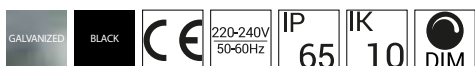


Art. 299
Art. 1269
Art. 1268



Art. 289
Art. 298
Art. 1469
Art. 1260

STOCKHOLM



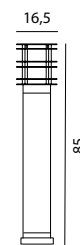
STOCKHOLM Heavy duty galvanized steel or galvanized and powder coated bollard with opal polycarbonate diffuser.

Art	Watt	Class	Type of light source	Luminous flux	Colour temperature	L70/B50	Diffuser	Height	Light control
288	-	II	E27	-	-	-	Opal	85cm	-
297	-	II	E27	-	-	-	Clear	85cm	-
1464	8,5W	II	LED E27	294 lm	2700K	25 000h	Opal	85cm	Yes
1265	8,5W	II	LED	342 lm	3000K	50 000h	Opal	85cm	Yes

ACCESSORIES Stockholm

205	Concreting anchor	p. 130
206	Anchoring support	p. 130

Art. 1464: 8,5W LED E27 included, 806lm, 2700K, 25000h dimmable. 2700/4000K or DALI available by request, contact your supplier.

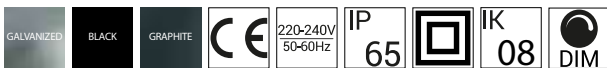


Art. 288
Art. 297
Art. 1464
Art. 1265





ARENDA L



ARENDA L Galvanized steel or galvanized and powder coated bollard. Tempered thick glass, frosted inside.

Art	Watt	Type of light source	Luminous flux	Colour temperature	L70/B50	Dimensions	Light control
1560	-	E27	-	-	-	85 x 12cm	-
1565	-	E27	-	-	-	49 x 12cm	-
1569	-	E27	-	-	-	35 x 12cm	-
1561*	4W	LED	330 lm	3000K	50 000h	64,2 x 9cm	Dim. Triac
1566*	4W	LED	330 lm	3000K	50 000h	64,2 x 9cm	Dim. Triac

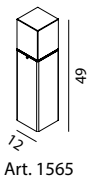
ACCESSORIES Arendal

205	Concreting anchor	For Art. 1560, 1565 i 1569	p. 130
206	Anchoring support	For Art. 1560, 1565 i 1569	p. 130
203	Concreting anchor	For Art. 1561 i 1566	p. 130
204	Anchoring support	For Art. 1561 i 1566	p. 130

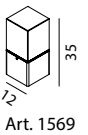
2700/4000K available by request, contact your supplier.



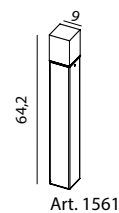
Art. 1560



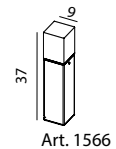
Art. 1565



Art. 1569



Art. 1561



Art. 1566



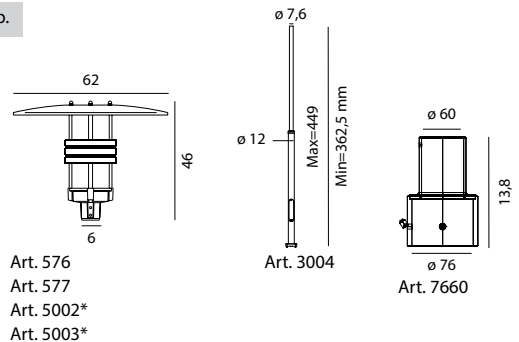
VISBY Powder coated aluminium, clear polycarbonate diffuser. For poles with 60mm external diameter at top.

Art	Watt	Type of light source	Luminous flux	Colour temperature	L70/B50	Light control
576	44,5W	2 LED	2465 lm	3000K	50 000h	On/off
5002	44,5W	2 LED	2616 lm	4000K	50 000h	On/off
577	27W	LED	1388 lm	3000K	50 000h	On/off
5003	27W	LED	1482 lm	4000K	50 000h	On/off

ACCESSORIES Visby

3004	Pole Ø76 - possibility of purchasing with dedicated accessories	p. 129
7660	Adapter Ø60 for install on pole Ø76	p. 130
154	Arm for use on wall	p. 130

2700/4000K or DALI2 available by request, contact your supplier.



Art. 576
Art. 5002*



Art. 577
Art. 5003*

VISBY



NICE



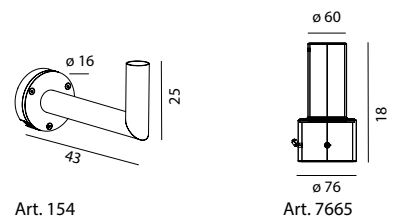
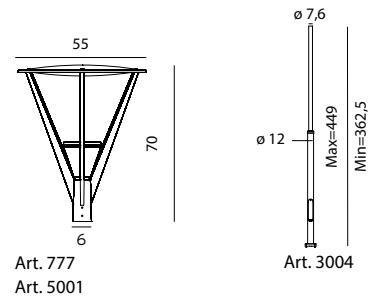
NICE Aluminium powder coated pole-top. Clear glass. For poles with 60mm external diameter at top.

Art	Watt	Type of light source	Luminous flux	Colour temperature	L70/B50	Light control
777	36,4W	LED	3190 lm	3000K	50 000h	On/off
5001	34,9W	LED	3240 lm	4000K	50 000h	On/off

Accessories Nicea

3004	Pole Ø76 - possibility of purchasing with dedicated accessories				p. 129
7665	Adapter Ø60 for install on pole Ø76				p. 130
154	Arm for use on wall				p. 130

2700/4000K or DALI available by request, contact your supplier.

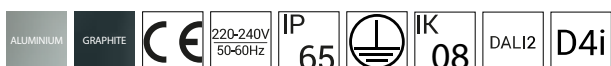




BORG



BORG ON POLE 3004
HEIGHT 4,5m



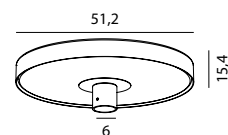
BORG Aluminium powder coated pole-top. For poles with 60mm top-diameter. diffuser PMMA.

Art	Watt	Type of light source	Luminous flux	Colour temperature	L70/B50	Light control	Diffuser	Ulor
5141	33W	LED	3735 lm	3000K	>72 000h	DALI2	Frosted	0%
5143	32W	LED	3735 lm	3000K	>72 000h	D4i	Frosted	0%
5146	33W	LED	2953 lm	3000K	>72 000h	DALI2	Opal	0%
5148	32W	LED	2996 lm	3000K	>72 000h	D4i	Opal	0%
6150	32W	LED	3735 lm	3000K	>72 000h	On/off	Frosted	0%
6151	32W	LED	2996 lm	3000K	>50 000h	On/off	Opal	0%
6153	53W	LED	6900 lm	3000K	>72 000h	DALI2	Clear	0%
6154	53W	LED	6900 lm	3000K	>72 000h	D4i	Clear	0%

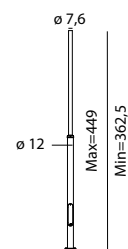
ACCESSORIES Borg

3004	Pole Ø76 - possibility of purchasing with dedicated accessories		p.129
7660	Adapter Ø60 for install on pole Ø76		p.130
154	Arm for use on wall		p.130

2700/4000K available by request, contact your supplier.

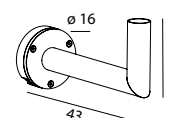


Art. 6150
Art. 6151
Art. 5140*
Art. 5141*



Art. 3004

PRO
PRO

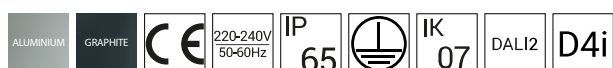


Art. 154





HAMMERFEST

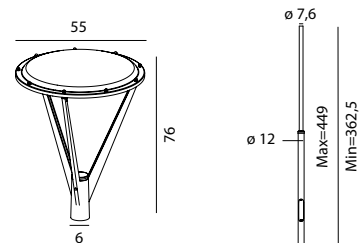


HAMMERFEST Aluminium powder coated pole-top. For poles with 60mm top-diameter. Diffuser PMMA.								
Art	Watt	Type of light source	Luminous flux	Colour temperature	L70/B50	Light control	Diffuser	Ulor
5131	32,5W	LED	3974 lm	3000K	>72 000h	DALI2	Frosted	2%
5136	32,5W	LED	3117 lm	3000K	>72 000h	DALI2	Opal	2%
6140	26,4W	LED	3869 lm	3000K	>50 000h	On/off	Frosted	2%
6141	32,7W	LED	3227 lm	3000K	>50 000h	On/off	Opal	2%
6146	52,1W	LED	5200 lm	3000K	>100 000h	DALI2	Clear	2%
6147	52,1W	LED	5200 lm	3000K	>100 000h	D4i	Clear	2%

ACCESSORIES Hammerfest

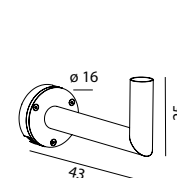
3004	Pole Ø76 - possibility of purchasing with dedicated accessories		p.129
7665	Adapter Ø60 for install on pole Ø76		p.130
154	Arm for use on wall		p.130

2700/4000K available by request, contact your supplier.

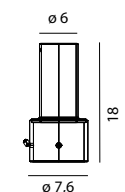


Art. 6140
Art. 6141
Art. 5130*
Art. 5135*

Art. 3004



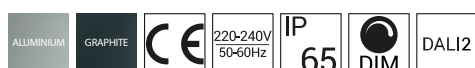
Art. 154



Art. 7665



EGERSUND PARK



EGERSUND PARK Aluminium powder coated pole. Ideal for path-way lighting where light pollution is an issue.

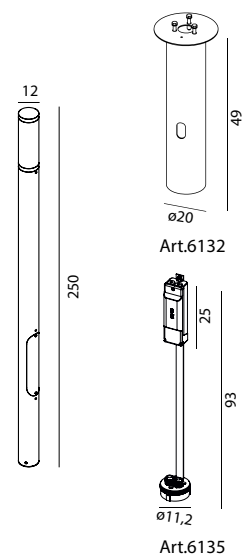
Art	Watt	Type of light source	Luminous flux	Colour temperature	L70/B50	Light control	Class	Ulor	Extra
6105	9,1W	LED	907 lm	3000K	>72 000h	Dim. Triac	II	1%	Inspection door.
6107*	9,1W	LED	962 lm	4000K	>72 000h	Dim. Triac	II	1%	Inspection door.
6113	23,7W	LED	2239 lm	3000K	>72 000h	DALI2	I	1%	Inspection door.
6115*	23,9W	LED	2314 lm	4000K	>72 000h	DALI2	I	1%	Inspection door.
6117	10W	LED	959 lm	3000K	>50 000h	Dim. Triac	II	2%	-
6118*	10W	LED	1064 lm	4000K	>50 000h	Dim. Triac	II	2%	-

ACCESSORIES Egersund park

6130	Concreting anchor	p.131
6132	Anchoring support 490mm	
6135	Electric box	for Art. 6105, 6107, 6113, 6115

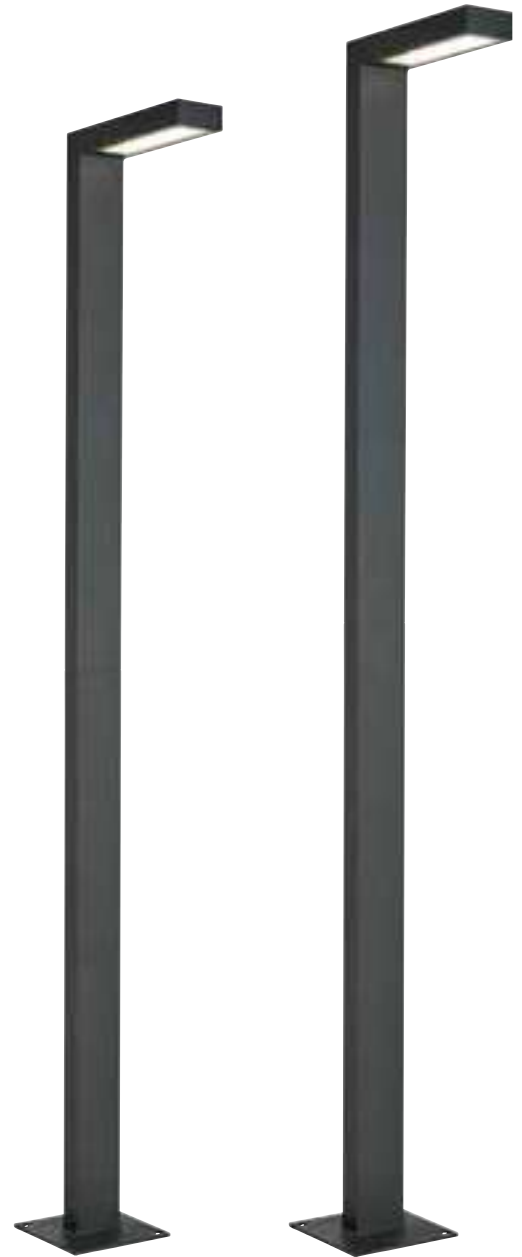
2700/4000K available by request, contact your supplier.

PRO
PRO





NEW
PRO



ASKER



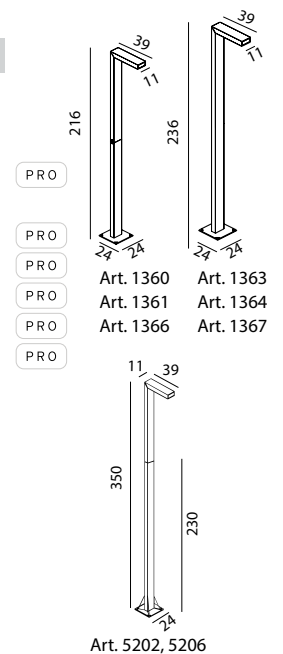
ASKER Aluminium powder coated pole. Ideal for path-way lighting where light pollution is an issue.

Art	Watt	Type of light source	Luminous flux	Colour temperature	L70/B50	Light control	IP	Version	Lens	Height
1360	18W	LED	962lm	3000K	50 000h	Dim. Triac	65/55	two-piece	-	216cm
1361	8,4W	LED	1033 lm	3000K	>120 000h	On/off	65/55	two-piece	IESNA Type III	216cm
1363	18W	LED	962 lm	3000K	50 000h	Dim. Triac	65	one-piece	-	236cm
1364	8,4W	LED	1033 lm	3000K	>120 000h	On/off	65	one-piece	IESNA Type V	236cm
1366	8,4W	LED	1018 lm	3000K	>120 000h	On/off	65/55	two-piece	IESNA Type III	216cm
1367	8,4W	LED	1033 lm	3000K	>120 000h	On/off	65	one-piece	IESNA Type III	236cm
5202	19,6W	LED	2550 lm	3000K	>120 000h	On/off	65/55	two-piece	IESNA Type V	350cm
5206	19,6W	LED	2520 lm	3000K	>120 000h	On/off	65/55	two-piece	IESNA Type III	350cm

ACCESSORIES Asker

116	Concreting anchor	p. 130
117	Anchoring support	p. 130

2700/4000K or DALI2 available by request, contact your supplier.





KISA

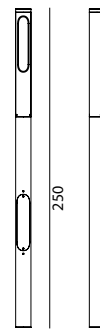


KISA Powder coated aluminium pole. Frosted PMMA diffuser.

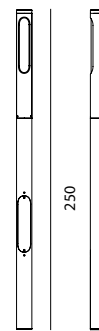
Art	Watt	Type of light source	Luminous flux	Colour temperature	L70/B50	Light control	Version
5190	8,8W	LED	706 lm	3000K	>70 000h	Dim. Triac	One-sided light
5191*	8,9W	LED	766 lm	4000K	>70 000h	Dim. Triac	One-sided light
5192	14,1W	LED	1185 lm	3000K	>70 000h	DALI2	One-sided light
5193*	14,2W	LED	1222 lm	4000K	>70 000h	DALI2	One-sided light
5194	15,2W	LED	1407 lm	3000K	>70 000h	Dim. Triac	Two-sided light
5195*	15,3W	LED	1450 lm	4000K	>70 000h	Dim. Triac	Two-sided light
5196	27W	LED	2432 lm	3000K	>70 000h	DALI2	Two-sided light
5197*	27,1W	LED	2500 lm	4000K	>70 000h	DALI2	Two-sided light

ACCESSORIES Kisa

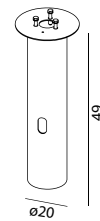
6130	Concreting anchor	p.131
6132	Anchoring support 490mm	
6135	Electric box	



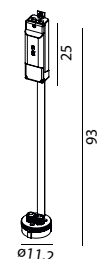
ø12
Art.5190, 5191,
5192, 5193



ø12
Art.5194, 5195,
5196, 5197



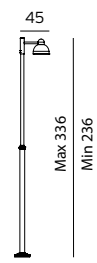
Art.6132



Art.6135

*2700/4000K available by request, contact your supplier.





Art. 1812, 1816, 1914

KOSTER

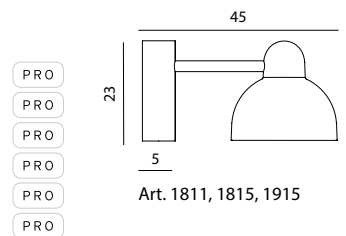


KOSTER Aluminium powder coated. Optical structure polycarbonate diffuser. Ideally suited for use in communal

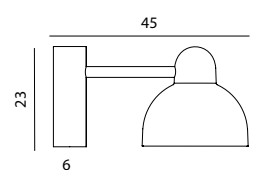
Art	Watt	Type of light source	Luminous flux	Colour temperature	L70/B50	Light control	Lens	Version
1811	14,4W	LED	1975 lm	3000K	>120 000h	On/off	IESNA Type III	Only lamp head Ø50
1812	14,4W	LED	1975 lm	3000K	>120 000h	On/off	IESNA Type III	Set with pole
1813	14,4W	LED	1975 lm	3000K	>120 000h	On/off	IESNA Type III	Only lamp head Ø60
1815	14,4W	LED	1991 lm	3000K	>120 000h	On/off	IESNA Type V	Only lamp head Ø50
1816	14,4W	LED	1991 lm	3000K	>120 000h	On/off	IESNA Type V	Set with pole
1817	14,4W	LED	1991 lm	3000K	>120 000h	On/off	IESNA Type V	Only lamp head Ø60
1913	17,5W	LED	1568 lm	3000K	50 000h	On/off	-	Only lamp head Ø60
1914	17,5W	LED	1568 lm	3000K	50 000h	On/off	-	Set with pole
1915	17,5W	LED	1568 lm	3000K	50 000h	On/off	-	Only lamp head Ø50

ACCESSORIES Koster

3004	Pole Ø76 - possibility of purchasing with dedicated accessories	p. 129	for Art. 1813, 1817, 1913
7660	Adapter Ø60 for mounting on pole Ø76	p. 130	for Art. 1813, 1817, 1913
405	Concreting anchor	p. 131	for Art. 1812, 1816, 1914
406	Anchoring support	p.131	for Art. 1812, 1816, 1914



Art. 1811, 1815, 1915



Art. 1813, 1817, 1913

2700/4000K or DALI2 available by request, contact your supplier.



STOCKHOLM

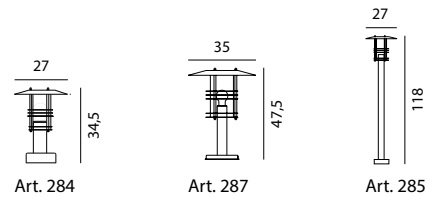


STOCKHOLM Galvanized steel or galvanized and powder coated fixture with clear polycarbonate diffuser.

Art	Watt	Class	Type of light source	Diffuser: PC	Light control	Height
284	-	II	E27	Clear	-	34,5cm
287	-	II	E27	Clear	-	47,5cm
285	-	II	E27	Clear	-	118cm

Accessories Art. 284, 285 and 287

Concreting anchor included for Art. 284, 285, 287.



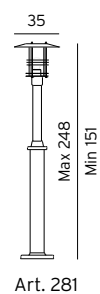


STOCKHOLM Adjustable pole fixture with single or double head for use with E27 light sources.

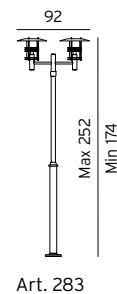
Art	Watt	Class	Type of light source	Diffuser: PC	Light control	Version
281	-	II	E27	Clear	-	Single head
283	-	II	2 x E27	Clear	-	Double head

Accessories Art. 281 i 283

405	Concreting anchor
406	Anchoring support



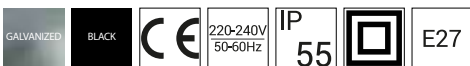
Art. 281



Art. 283



LUND

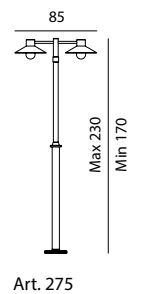
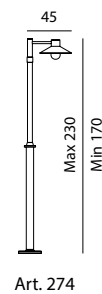


LUND Adjustable pole fixture with single or double head for use with E27 light sources.

Art	Watt	Class	Type of light source	Diffuser: PC	Light control	Version
274	-	II	E27	Clear	-	Single head
275	-	II	2 x E27	Clear	-	Double head

ACCESSORIES Lund

405	Concreting anchor
406	Anchoring support



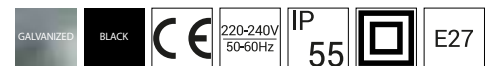
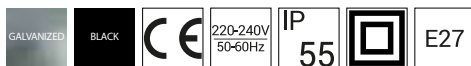


KARLSTAD

NEW



OSLO



OSLO Adjustable pole fixture with single or double head for use with E27 light sources.

Art	Watt	Class	Type of light source	Diffuser: PC	Light control	Version	Type
245	-	II	E27	Clear	-	Single head	Pillar
Art. 245: Concreting anchor included							
242	-	II	2 x E27	Clear	-	Double head	Pole

ACCESSORIES Oslo

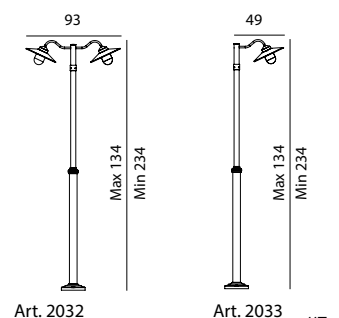
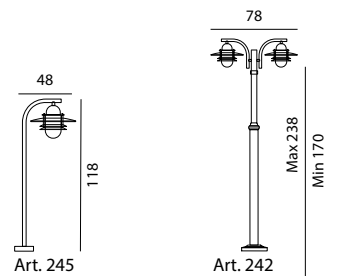
405	Concreting anchor		for Art. 242	p. 131
406	Anchoring support		for Art. 242	p. 131

KARLSTAD Adjustable pole fixture with single or double head for use with E27 light sources.

Art	Watt	Class	Type of light source	Diffuser: PC	Light control	Version	Type
2032	-	II	2 x E27	Clear	-	Double head	Pole
2033	-	II	E27	Clear	-	Single head	Pole

ACCESSORIES Karlstad

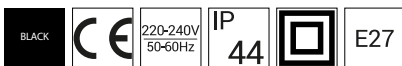
405	Concreting anchor		for Art. 2032, 2033	p.131
406	Anchoring support		for Art. 2032, 2033	p.131







LOFOTEN

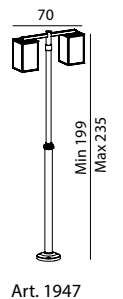
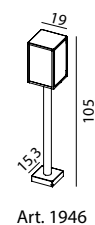
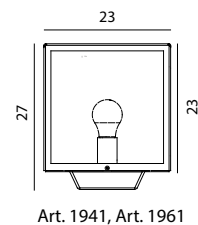


LOFOTEN Classic powder coated steel (electrogalvanized) pedestal, pillar or pole fixture with clear or opal glass.

Art	Watt	Class	Type of light source	Light control	Version	Diffuser
1941	-	II	E27	-	Single head	Clear
1961	-	II	E27	-	Single head	Opal
1946	-	II	E27	-	Single head	Clear
1947	-	II	2 x E27	-	Double head	Clear

Accessories for Lofoten Art. 1946,1947

205	Concreting anchor	p. 130	For Art. 1946
206	Anchoring support	p. 130	For Art. 1946
405	Concreting anchor	p. 131	For Art. 1947
406	Anchoring support	p. 131	For Art. 1947





LONDON



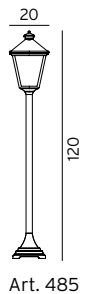
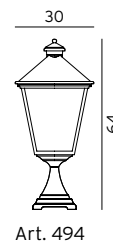
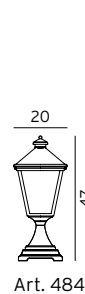
BLACK
WHITE
CE
220-240V
50-60Hz
IP 54
E27
DALI2

LONDON Aluminium powder coated fixtures with clear polycarbonate diffuser.

Art	Watt	Class	Type of light source	Diffuser: PC	Light control
484	-	II	E27	Clear	-
494	-	II	E27	Clear	-
485	-	II	E27	Clear	-

Accessories London for Art. 484, 485 and 494

307	Concreting anchor	p. 130
-----	-------------------	--------





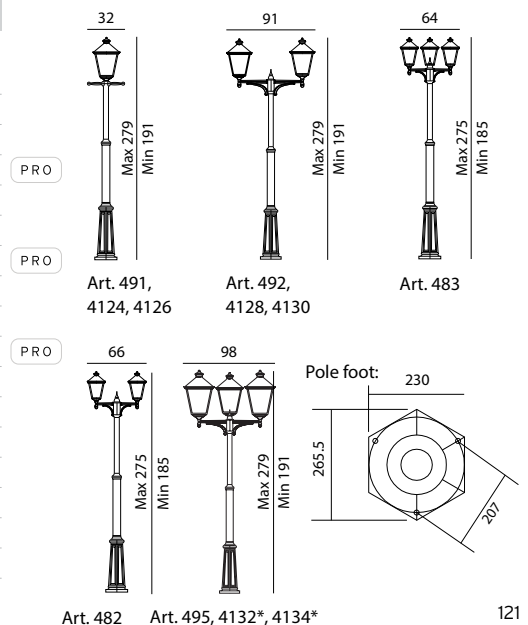
LONDON Aluminium powder coated fixtures with clear polycarbonate diffuser.

Art	Watt	Type of light source	Luminous flux	Colour temperature	L70/B50	Light control	Lens
491	-	E27	-	-	-	-	-
4124*	17,5W	LED	1392 lm	3000K	50 000h	On/off	-
4126*	19,4W	LED	2000 lm	3000K	>120 000h	DALI2	IESNA Type VS
492	-	2 x E27	-	-	-	-	-
4128*	35W	2 x LED	2784 lm	3000K	50 000h	On/off	-
4130*	38,8W	2 x LED	4000 lm	3000K	>120 000h	DALI2	IESNA Type VS
495	-	3 x E27	-	-	-	-	-
4132*	52,5W	3 x LED	4176 lm	3000K	50 000h	On/off	-
4134*	58,2W	3 x LED	6000 lm	3000K	>120 000h	DALI2	IESNA Type VS
483	-	3 x E27	-	-	-	-	-
482	-	2 x E27	-	-	-	-	-

Accessories London

305	Concreting anchor	p.131
306	Anchoring support	p.131
3010	Pole	p.129
30101	Pole	p.129

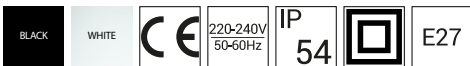
*London LED with 2700/4000K available by request, contact your supplier.



Art. 482 Art. 495, 4132*, 4134*

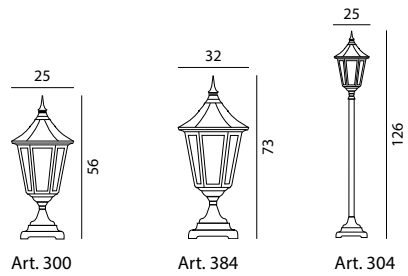


MODENA



MODENA Aluminium powder coated fixtures with clear polycarbonate diffuser.

Art	Watt	Class	Type of light source	Diffuser: PC	Light control
300	-	II	E27	Clear	-
384	-	II	E27	Clear	-
304	-	II	E27	Clear	-
Accessories Modena					
307	Concreting anchor		p. 131		



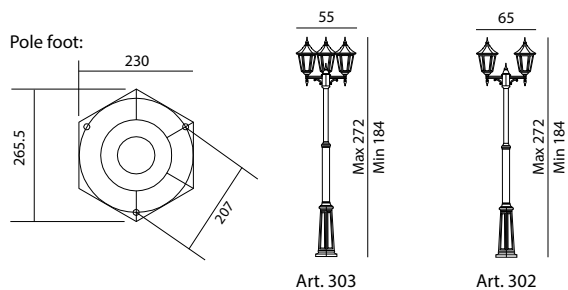
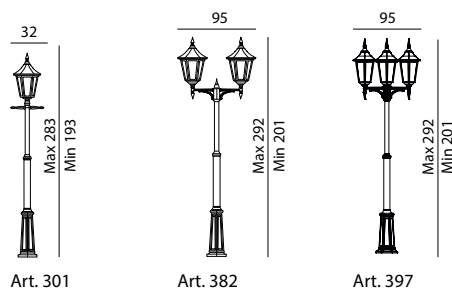


MODENA Aluminium powder coated fixtures with clear polycarbonate diffuser.

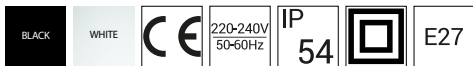
Art	Watt	Class	Type of light source	Diffuser: PC	Light control
301	-	II	E27	Clear	-
382	-	II	2xE27	Clear	-
303	-	II	3xE27	Clear	-
302	-	II	2xE27	Clear	-
397	-	II	3xE27	Clear	-

Accessories Modena

305	Concreting anchor	p. 131
306	Anchoring support	p. 131
3010	Pole	p. 129
30101	Pole	p. 129



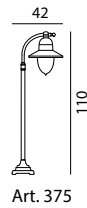
COMO



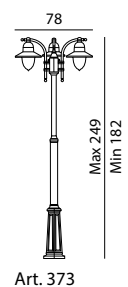
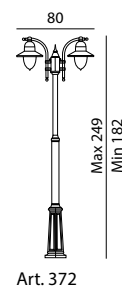
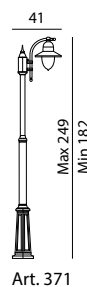
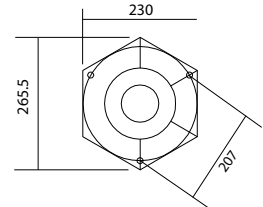
COMO Aluminium powder coated fixtures with clear polycarbonate diffuser.					
Art	Watt	Class	Type of light source	Diffuser: PC	Version
375	-	II	E27	Clear	Pillar
371	-	II	E27	Clear	Pole
372	-	II	2xE27	Clear	Pole
373	-	II	3xE27	Clear	Pole

Accessories Como

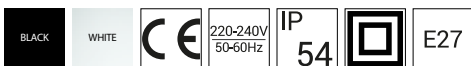
305	Concreting anchor	for Art. 371, 372, 373	p. 131
306	Anchoring support	for Art. 371, 372, 373	p. 131
3010	Pole		p. 129
30101	Pole		p. 129
307	Concreting anchor	for Art. 375	p. 131



Pole foot: Art. 371, 372 i 373



FIRENZE

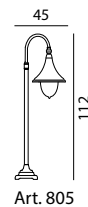


FIRENZE Aluminium powder coated fixtures with clear polycarbonate diffuser.

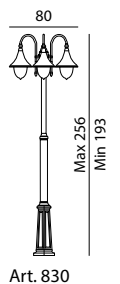
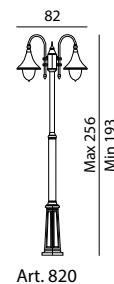
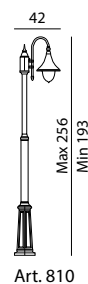
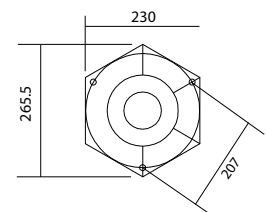
Art	Watt	Class	Type of light source	Diffuser: PC	Version
805	-	II	E27	Clear	Pillar
810	-	II	E27	Clear	Pole
820	-	II	2xE27	Clear	Pole
830	-	II	3xE27	Clear	Pole

ACCESSORIES FIRENZE

305	Concreting anchor	for Art. 810, 820, 830	p. 131
306	Anchoring support	for Art. 810, 820, 830	p. 131
3010	Pole		p. 129
30101	Pole		p. 129
307	Concreting anchor	for Art. 805	p. 131



Pole foot: Art. 810, 820 i 830



RIMINI/MILANO

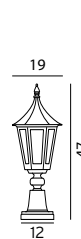


RIMINI/MILANO Aluminium powder coated fixtures with clear polycarbonate diffuser.

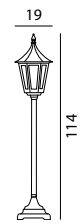
Art	Watt	Class	Type of light source	Diffuser: PC	Version
250	-	II	E27	Clear	Pedestal
404	-	II	E27	Clear	Pillar
401	-	II	E27	Clear	Pole
402	-	II	2xE27	Clear	Pole
403	-	II	3xE27	Clear	Pole

Accessories Rimini/Milano

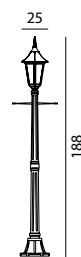
405	Concreting anchor	for Art. 401, 402, 403 p. 131
406	Anchoring support	for Art. 401, 402, 403 p. 131
307	Concreting anchor	for Art. 250, 404 p. 131



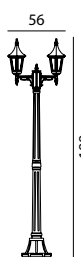
Art. 250



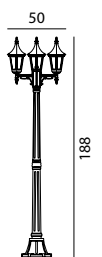
Art. 404



Art. 401



Art. 402



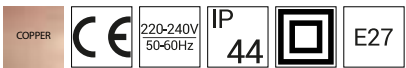
Art. 403



CHELSEA



NEW

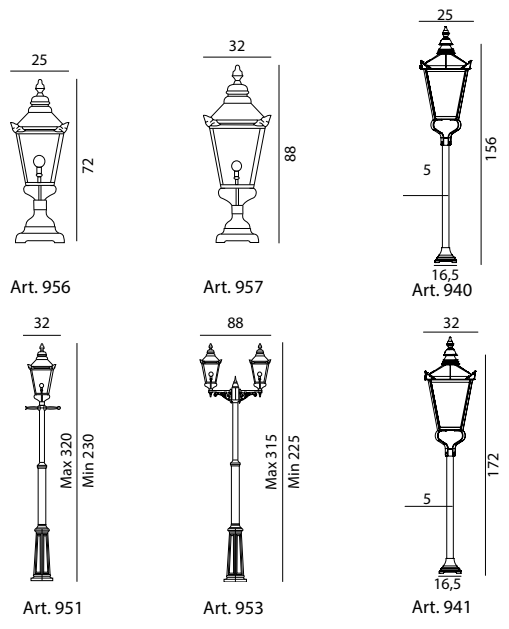


CHELSEA Handmade copper fixtures heads. Supplied with clear polycarbonate diffuser.

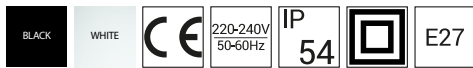
Art	Watt	Class	Type of light source	Diffuser: PC	Version
940	-	II	E27	Clear	Pillar
941	-	II	E27	Clear	Pillar
956	-	II	E27	Clear	Pedestal
957	-	II	E27	Clear	Pedestal
951	-	II	E27	Clear	Pole
953	-	II	2xE27	Clear	Pole

Accessories Chelsea

305	Concreting anchor	for Art. 951, 953	p. 131
306	Anchoring support	for Art. 951, 953	p. 131
307	Concreting anchor	for Art. 940, 941, 956, 957	p. 131



BOLOGNA

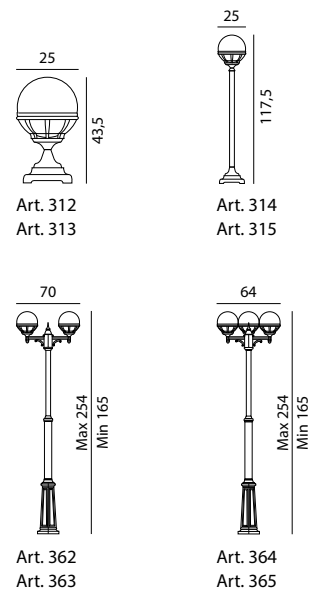


BOLOGNA Aluminium powder coated fixtures with clear or opal PMMA diffuser.

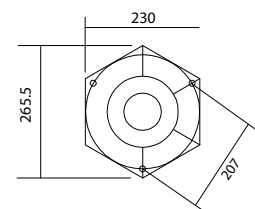
Art	Watt	Class	Type of light source	Diffuser	Version
312	-	II	E27	Clear	Pedestal
313	-	II	E27	Opal	Pedestal
314	-	II	E27	Clear	Pillar
315	-	II	E27	Opal	Pillar
362	-	II	2xE27	Clear	Pole
363	-	II	2xE27	Opal	Pole
364	-	II	3xE27	Clear	Pole
365	-	II	3xE27	Opal	Pole

ACCESSORIES BOLOGNA

305	Concreting anchor	for Art. 362, 363, 364, 365	p. 131
306	Anchoring support	for Art. 362, 363, 364, 365	p. 131
307	Concreting anchor	for Art. 312, 313, 314, 315	p. 131



Pole foot: Art. 362 - 365

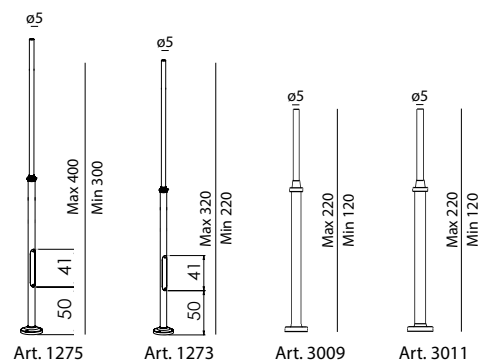




POLES as accessories.

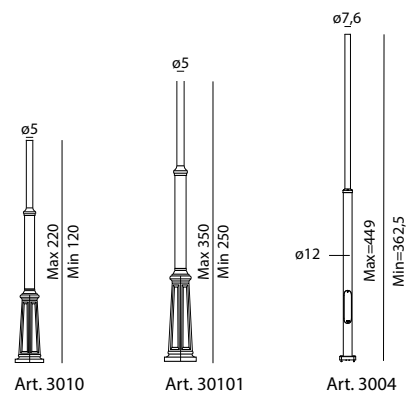
Art	Color	ø mm	Info
1273	Aluminium, Graphite	ø50mm	Made of aluminium, for painted fittings.
1275	Aluminium, Graphite	ø50mm	Made of aluminium, for painted fittings.
3009	Galvanized	ø50mm	Made of steel, for galvanized fittings.
3010	Black, White	ø50mm	Made of aluminium, for classic fittings.
30101	Black, White	ø50mm	Made of aluminium, for painted fittings.
3011	Black,	ø50mm	Made of aluminium, for painted fittings.
3004	Aluminium, Graphite	ø76mm	Made of aluminium, for painted fittings.

For luminaires: VISBY, BORG, HAMMERFEST, NICE and KOSTER. For public use, parks, parking lots.



Accessories

305	Concreting anchor	For Art. 3010 and 30101	p. 131
306	Anchoring support	For Art. 3010 and 30101	p. 131
405	Concreting anchor	For Art. 1273, 3009 and 3011	p. 131
406	Anchoring support	For Art. 1273, 3009 and 3011	p. 131
7660	Adapter Ø60 for Ø76 pole (short version)	For Art. 3004	p. 130
7661	Electric box	For Art. 3004	p. 130
7662	Electric box (EK 480 G1S-2D)	For Art. 3004	p. 130
7664	Concrete foundation	For Art. 3004	p. 130
7665	Adapter Ø60 for Ø76 pole (long version)	For Art. 3004	p. 130



Art. 3060
Reduction for Ø50 fittings for mounting on Ø60 pole

Art. 3061
Reduction for luminaires Art. 3012, 4012 for mounting on Ø60 pole

Art. 3070
Reduction for Ø60 fittings for mounting on Ø50 pole

Art. 159
Spacer
Art: 230
Art: 240
Art: 270
Art: 280, 286
Art: 290
Art: 690
Art: 1920

Art. 3080
Adapter
Halmstad
Alta
Stockholm
Oppland
Scandinavian wood
Lillesand

Art. 150
Corner bracket
Art: 259, 2591

Art. 152
Corner bracket
Art: 310, 311, 360, 361
Art: 350, 351, 380, 381
Art: 370
Art: 480, 481, 490, 493
Art: 800
Art: 954, 960

Art. 153
Corner bracket
Art: 230
Art: 240
Art: 270
Art: 280, 286
Art: 290
Art: 690
Art: 1920

Art. 154
Arm for wall
Art: 576, 577
Art: 777
Art: Borg
Art: Hammerfest

Art. 155
Corner bracket
Art: 1943

Art. 158
Corner bracket
Art: 724, 725, 1912

Art. 7660
Reduction for Ø60 fittings for mounting on Ø76 pole, to be used with Visby, Koster

Art. 7661
Junction box with 5-way terminal block

Art. 7662
Electric box for pole
Art: 3004 (EK 480 G15-2D)

Art. 7664
Concrete foundation to be buried in the ground for pole Art. 3004

Art. 7665
Reduction for Ø60 fittings for mounting on Ø76 pole, to be used with Nice, Hammerfest

Art. 112
Concreting anchor
Art: 1931, 1932

Art. 113
Anchoring support
Art: 1931, 1932

Art. 116
Concreting anchor
Art: 1360, 1363

Art. 117
Anchoring support
Art: 1360, 1363

Art. 203
Concreting anchor
Art: 1561, 1566, Borg Bollard

Art. 204
Anchoring support
Art: 1561, 1566

Art. 205
Concreting anchor
Art: 210, 211, 288, 289, 291, 293, 295, 296, 297, 298, 299, 1260, 1265, 1268, 1290, 1291, 1321, (1400-1453)
1477, 1479, 1482, 1483, 1488, 1488

Art. 206
Anchoring support
Art: 210, 211, 288, 289, 291, 293, 295, 296, 297, 298, 299, 1260, 1265, 1268, 1290, 1291, 1321, (1400-1453)
1477, 1479, 1482, 1483, 1488, 1488

Art. 208
Concreting anchor
 Art: 891, 893, 898, 899

Art. 305
Concreting anchor
 Art: 301, 302, 303, 382
 Art: 362, 363, 364, 365
 Art: 371, 372, 373
 Art: 482, 483, 493, 492
 Art: 810, 820, 830
 Art: 951, 953

Art. 306
Anchoring support
 Art: 301, 302, 303, 382
 Art: 362, 363, 364, 365
 Art: 371, 372, 373
 Art: 482, 483, 493, 492
 Art: 810, 820, 830
 Art: 951, 953

Art. 307
Concreting anchor
 Art: 300, 304, 384
 Art: 312, 313, 314, 315
 Art: 484, 485, 494
 Art: 805
 Art: 956, 957

Art. 405
Concreting anchor
 Art: 242
 Art: 274, 275
 Art: 281, 283
 Art: 401, 402, 403
 Art: 1914
 Lofoten

Art. 406
Anchoring support
 Art: 242
 Art: 274, 275
 Art: 281, 283
 Art: 401, 402, 403
 Art: 1914

Art. 505
Concreting anchor
 Art: 557

Art. 1230
Concreting anchor
 Art: 1240, 1243, 1244,
 1246, 1248, 1248
 Art: 1280, 1285

Art. 1231
Anchoring support
 Art: 1240, 1243, 1244,
 1246, 1248, 1248
 Art: 1280, 1285

Art. 1907
Concreting anchor
 Art: 1311, 1312
 Art: 1901

Art. 1908
Anchoring support
 Art: 1311, 1312
 Art: 1901

Art. 6130
Concreting anchor
 Art: 6105

Art. 130
Corner bracket
 Mandal
 Art: 1373, 1374

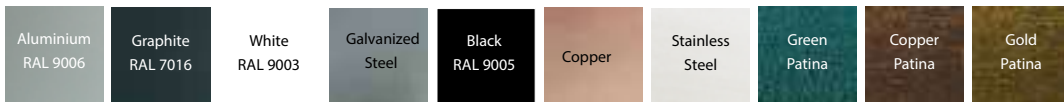
Art. 144
Hermetic junction box
 Egersund Mini,
 Lillesand, Oppland

Art. 148
Corner bracket
 Sandvik
 Art: 1730, 1731, 1732,
 1740, 1741, 1742

Art. 149
Corner bracket
 Mandal
 Art: 1370, 1371

Art. 151
Corner bracket
 Hitra

Art. 202
Anchoring support
 Borg Bollard



Patina is available only in the black color and at a surcharge of 10%. Colors are marked as non-standard for an additional 30% and with an extended delivery date.



The colors of the produced fittings may slightly differ from those presented in this catalog

Color temperature (Kelvin)





Norlys AS
P.B 1014 Hoff, 0218 Oslo
Havfaret 4B, 0275 Oslo

 www.norlys.com
 +47 24 12 40 10
 firmapost@norlys.no